



GODFREY

PONTOON BOATS



EST.



1958

*Our pontoons, like the memories you'll make on them,
will always stand the test of time.*



XP

SANPAN

AQUAPATIO

MONACO

SWEETWATER

XPERIENCE

MIGHTY G



CONTENTS

04	XP
10	Sanpan
22	AquaPatio
36	Monaco
50	Lifestyle
52	Sweetwater
66	Xperience
76	Mighty G
82	Exterior Options
84	Interior Options
86	Performance Packages
88	Why Godfrey
89	Godfrey Advantage
90	Apparel & Accessories
91	Warranty & Important Notices

XP

PERFORMANCE FOR THE BOLD

The XP series is the epitome of luxury, pontoon performance, and fun on the water, allowing you to enjoy your favorite moments with your favorite people. Experience cutting-edge features, unbeatable performance and comfort like never before. Enjoy the water from every angle, so you can kick back, relax and take it all in.

Make It Last.

Standard Equipment

- 29" iMPACT+ Triple Tube
29" Center Tube;
Two 27" Outer Tubes
- Powered Action Tower with
Integrated 11' Power Canopy
- Innovative Helm with Enovation
Controls® 12" Wide Display & 7"
Display, 12" Multi-Function Display
(Garmin® or Simrad®), Graphite
Helm Panels & Lockable Storage
- JL® Audio System with MM105-
HR Head Unit, Three Amps with
2600W Amplification, Four 8.8"
& Four 7.7" RGB Speakers, Two
12" RGB Subwoofers, NMEA
Volume Knob & Stern Remote
- Reclining Captain's & Co-
Captain's Chairs with Bolsters
- Cooled Cupholders & Wireless
Phone Chargers for both
Captain & Co-Captain
- Stainless Steel Comfort
Climb Ladder
- Removable Ski Tow Pylon
- Bow & Stern USB A/C
Charging Ports
- Nightshade Towable Boat Cover
- Addressable RGB Lighting
- LED Lit Rectangular Table

Popular Options

- Cool Touch Furniture
- JL® Audio Tower Speakers
- In-Floor Storage
- Onyx Designer Select Package
- Additional Port Stern Ladder
- Lillipad® Ladder

*Unleash the
Power*





XP 2500 with Pearl White Exterior & Pearl White Furniture with Matador Red Accent

XP TWIN ENGINES



Standard Equipment for XP Twin Engines

- Quad Battery System with Trays & Charger
- Ski Tow Pylon
- Windscreen or Windshield Models

Popular Options for XP Twin Engines

- 600 HP - 1000 HP Options
- Mercury® Racing Engines
- Joystick Steering

Additional key XP Standards & Popular Options shown on pg 4



XP's innovative helm featuring Enovation Controls® 12" Wide Display & 7" Display, 12" Multi-Function Display, Graphite Helm Panels & Lockable Storage

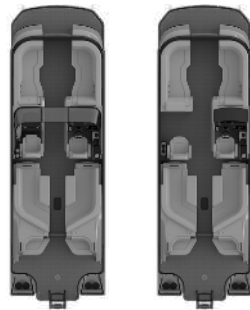

XP	2700 W Twin	2700 Twin
LOA/Deck	27' 5" / 27' 4"	27' 5" / 27' 4"
Pontoon Length	26' 10"	26' 10"
Beam	8' 6"	8' 6"
Pontoon Diameter	29" iMPACT+	29" iMPACT+
Fuel Capacity (GAL)	121	121
Person Capacity	9-12	9-12

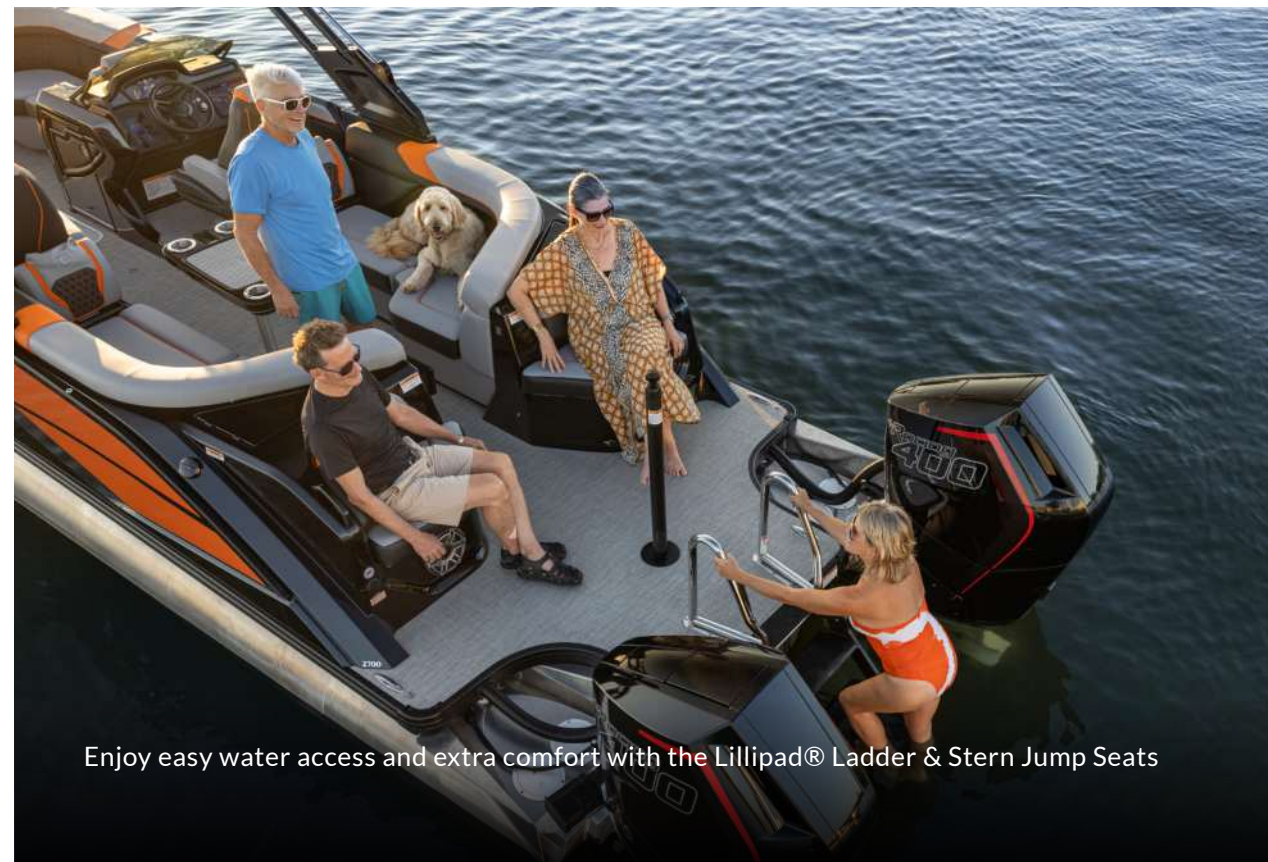

Enjoy easy water access and extra comfort with the Lillipad® Ladder & Stern Jump Seats



[Click Here to Learn
More About the
XP Twin Engine](#)

XP TWIN ENGINE

For those who demand more, the XP Series offers an available twin-engine configuration, delivering unmatched power and excitement for the ultimate pontoon experience.

XP 2700 Twin with Calypso Orange Exterior & Slate Gray Furniture with Calypso Orange Accent



[Click Here to Learn
More About the
XP Single Engine](#)

The XP Series delivers refined luxury and elite performance with a powerful single-engine design. Perfect for smooth handling and unforgettable days on the water.

XP 2500 with Pearl White Exterior & Pearl White Furniture with Matador Red Accent

XP SINGLE ENGINE



Experience wind protection with the XP's walk-thru, low profile Windshield

XP SINGLE ENGINE



Standard Equipment for XP Single Engines

- Triple Battery System with Trays & Charger
- Windscreen or Windshield Models
- Seastar® Power Assist
- Lifting Eye Access Ports

Popular Options for XP Single Engines

- Engines up to 400 HP

Additional key XP Standards & Popular Options shown on pg 4



Relax and enjoy the view from the XP's plush Stern Jump Seats



XP	2700 W	2700	2500 W	2500
LOA/Deck	28' 4" / 27' 8"	28' 4" / 27' 8"	26' / 25' 9"	26' / 25' 9"
Pontoon Length	26' 6"	26' 6"	24' 2"	24' 2"
Beam	8' 6"	8' 6"	8' 6"	8' 6"
Pontoon Diameter	29" iMPACT+	29" iMPACT+	29" iMPACT+	29" iMPACT+
Fuel Capacity (GAL)	63	63	63	63
Person Capacity	15	15	14	14

SANPAN

THE ULTIMATE IN PONTOON LUXURY

Designed to bring people together in style with uncompromising comfort, our Godfrey Sanpan series exceeds our own boundaries and sets the standard for luxury pontoons. Where fresh air and laughter meets the ultimate boating experience, our Sanpan series captures Godfrey's commitment to excellence and superior performance. Standard with top of the line amenities, enjoy a lifetime of quality and leisure that exceeds expectations.

Make it Last

Standard Equipment

- 27" iMPACT Triple Tube
27" Center Tube;
Two 25" Outer Tubes
(N/A Twin Models)
- Power Canopy
- 12" Multi-Function Display
- Fiberglass Railskin
- Ultra Soft Touch,
Quilted Furniture
- Clarion® Platinum Plus Audio
System with CMR-30 Color LCD
Remote, Clarion® Black Box, Seven
Channel 950W Amplifier, Four 6.5"
& Two 7.7" RGB Speakers, Chrome
Sport Grilles & 10" RGB Subwoofer
- Full Spectrum RGB
Lighting Package
- Click & Cruise Rail Technology
- Stainless Steel Comfort Climb
Ladder or Lillipad® Ladder
- Ultimate Ski Tow
- Headlight with Integrated
Navigation & Docking Lights
- Wireless Phone Charger
- Bow & Stern USB A/C
Charging Ports
- Cooled Captain's Cupholder
- Auto Navigation & Anchor Lights

Popular Options

- Grand Luxe Power Actuated Arch
with integrated Power Canopy
- Anchor Bracket for
In-Floor Storage
- Bolster or Heated Helm Seats
- JL® Audio System
- JL® Audio Tower or Arch Speakers
- Joystick Controls
- Windlass Anchor with
Quick-release
- Cool Touch Furniture &
Flooring Options
- Cooled Co-Captain's Cupholder
- Upgraded Sport Steering Wheel

*The definition
of leisure*





SP 2500 MTF with Pacific Fiberglass Exterior & Riverstone Ultra Soft Furniture



[Click Here to Learn
More About the
Sanpan Twin](#)

**Unleash the epitome of pontoon performance on one of our Sanpan Twin models.
Unbeatable style, comfort, and convenience seamlessly blend together in 27-foot lengths.**

SP 2700 SBW Twin with Black Fiberglass Exterior & Raven Cool Touch Furniture

**SANPAN
TWIN**



Unleash the ultimate performance with Twin Engines delivering up to 1000 HP



Indulge in comfort & premium sound with our Latte Ultra Soft Interior & JL® Audio Package

SANPAN TWIN



Standard Equipment for Sanpan Twin

- 29" iMPACT+ Triple Tube 29" Center Tube; Two 27" Outer Tubes
- Deluxe Captain's & Co-Captain's Reclining Chairs with Adjustable Removable Pedestals
- Windscreen or Windshield Models
- Ski Tow Pylon

Popular Options for Sanpan Twin

- 600 - 1000 HP
- Joystick Steering

Additional key Sanpan Standards & Popular Options shown on pg 10



Crafted for style and sophistication, experience elegance & full-width wind protection with our sleek, low-profile walk-thru Windshield

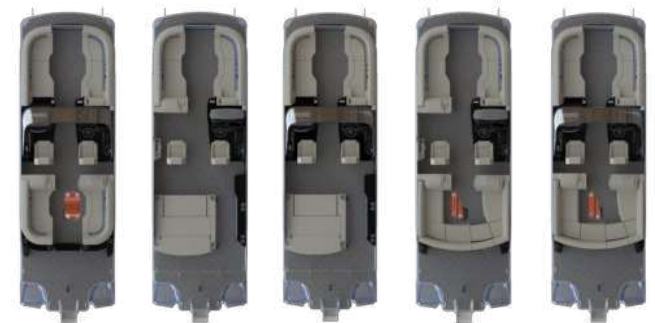

SANPAN	2700 SBW Twin	2700 SFLC Twin	2700 SFLW Twin	2700 ULC Twin	2700 ULW Twin
LOA/Deck	27' 5" / 27' 4"	27' 5" / 27' 4"	27' 5" / 27' 4"	27' 5" / 27' 4"	27' 5" / 27' 4"
Pontoon Length	26' 10"	26' 10"	26' 10"	26' 10"	26' 10"
Beam	8' 6"	8' 6"	8' 6"	8' 6"	8' 6"
Pontoon Diameter	29" iMPACT+	29" iMPACT+	29" iMPACT+	29" iMPACT+	29" iMPACT+
Fuel Capacity (GAL)	121	121	121	121	121
Person Capacity	11 - 16	11 - 16	11 - 16	11 - 16	11 - 16



[Click Here to Learn
More About the
Sanpan Windshield](#)

Always moving, our Sanpan Windshield models are available in 25 to 27-foot configurations and deliver port to starboard wind protection.

SP 2700 ULW Twin with Anthracite Fiberglass Exterior & Saddle Cool Touch Furniture

SANPAN WINDSHIELD



Seamless design meets functionality with the integrated full-width walk-thru Windshield

SANPAN WINDSHIELD



Standard Equipment for Sanpan Windshield

- Walk-Thru Windshield
- Port Helm with Co-Captain's Chair
- Lounge or Split Bench Layouts with the Protection of a Windshield

Popular Options for Sanpan Windshield

- Windblock Curtain
- Additional Ladder on Portside (N/A Twin Models)

Additional key Sanpan Standards & Popular Options shown on pg 10



Spacious storage & comfortable, elevated seating standard for the Co-Captain of your choice

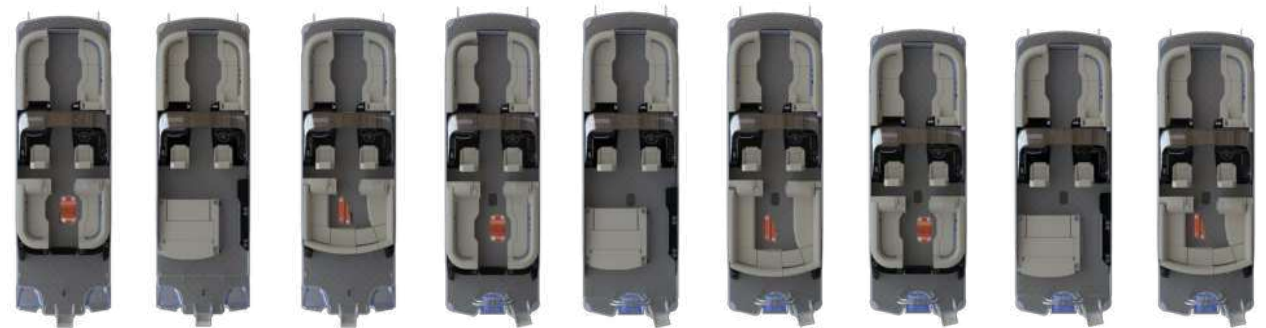

SANPAN	2700 SBW Twin	2700 SFLW Twin	2700 ULW Twin	2700 SBW	2700 SFLW	2700 ULW	2500 SBW	2500 SFLW	2500 ULW
LOA/Deck	27' 5" / 27' 4"	27' 5" / 27' 4"	27' 5" / 27' 4"	28' 1" / 27' 7"	28' 1" / 27' 7"	28' 1" / 27' 7"	25' 9" / 25' 7"	25' 9" / 25' 7"	25' 9" / 25' 7"
Pontoon Length	26' 10"	26' 10"	26' 10"	26' 6"	26' 6"	26' 6"	24' 2"	24' 2"	24' 2"
Beam	8' 6"	8' 6"	8' 6"	8' 6"	8' 6"	8' 6"	8' 6"	8' 6"	8' 6"
Pontoon Diameter	29" iMPACT+	29" iMPACT+	29" iMPACT+	27" iMPACT	27" iMPACT	27" iMPACT	27" iMPACT	27" iMPACT	27" iMPACT
Fuel Capacity (GAL)	121	121	121	48	48	48	48	48	48
Person Capacity	11 - 16	11 - 16	11 - 16	14	14	14	16	16	16



[Click Here to Learn More About the Sanpan Lounge](#)

The smooth, dynamic styling and first-class interior makes our Sanpan Lounge the perfect place to gather with friends.

SP 2500 ULW with Lagoon Fiberglass Exterior & Latte Ultra Soft Furniture

SANPAN LOUNGE



Ultra Lounge layout with Godfrey's premium fiberglass closeout



Smart, easy-access storage designed for convenience

SANPAN LOUNGE



Standard Equipment for Sanpan Lounge

- Single Flip Lounge Unit with Various Seating Configurations on SFL Models
- Spacious U-Shaped Design with a Stern Table on ULC Models
- Single Flip Lounge Unit & Flip Seat for Co-Captain with Large, Stationary Table on MTF Models
- Fiberglass Stern Storage Cabinet on SFL & MTF Models
- Safety Barrier & Gate on SFL & MTF Models
- Railside Cupholder by Chair (N/A MTF & W Models)
- Triangular Table with Cupholders on UL Models

Popular Options for Sanpan Lounge

- In-Floor Storage with Anchor Bracket
- Rectangular Table on UL Models

Additional key Sanpan Standards & Popular Options shown on pg 10



SANPAN	2700 SFLC Twin	2700 SFLW Twin	2700 ULC Twin	2700 ULW Twin	2700 MTF	2700 SFLC	2700 SFLW	2700 ULC	2700 ULW	2500 MTF	2500 SFLC	2500 SFLW	2500 ULC	2500 ULW	2300 ULC
LOA/Deck	27' 5" / 27' 4"	27' 5" / 27' 4"	27' 5" / 27' 4"	27' 5" / 27' 4"	28' 1" / 27' 7"	28' 1" / 27' 7"	28' 1" / 27' 7"	28' 1" / 27' 7"	28' 1" / 27' 7"	25' 9" / 25' 7"	25' 9" / 25' 7"	25' 9" / 25' 7"	25' 9" / 25' 7"	25' 9" / 25' 7"	23' 11" / 23' 7"
Pontoon Length	26' 10"	26' 10"	26' 10"	26' 10"	26' 6"	26' 6"	26' 6"	26' 6"	26' 6"	24' 2"	24' 2"	24' 2"	24' 2"	24' 2"	22' 4"
Beam	8' 6"	8' 6"	8' 6"	8' 6"	8' 6"	8' 6"	8' 6"	8' 6"	8' 6"	8' 6"	8' 6"	8' 6"	8' 6"	8' 6"	8' 6"
Pontoon Diameter	29" iMPACT+	29" iMPACT+	29" iMPACT+	29" iMPACT+	27" iMPACT	27" iMPACT	27" iMPACT	27" iMPACT	27" iMPACT	27" iMPACT	27" iMPACT	27" iMPACT	27" iMPACT	27" iMPACT	27" iMPACT
Fuel Capacity (GAL)	121	121	121	121	48	48	48	48	48	48	48	48	48	48	48
Person Capacity	11 - 16	11 - 16	11 - 16	11 - 16	14	14	14	14	14	16	16	16	16	16	13



[Click Here to Learn More About the Sanpan Split Bench](#)

Unwind in style with bow and stern lounge seating, available in 23, 25 and 27-foot length options, perfectly complemented by co-captain's chairs in an inviting open-deck design.

SP 2700 SBW Twin with Black Fiberglass Exterior & Raven Cool Touch Furniture

SANPAN SPLIT BENCH



Helm featuring a 12" Multi-Function Display & 9" Envelope Display for total control & clarity

SANPAN SPLIT BENCH



Standard Equipment for Sanpan Split Bench

- Bow & Stern Quad Benches for Storage & Comfortable Seating
- Rectangular Table
- Co-Captain's Seat

Popular Options for Sanpan Split Bench

- Twin Engine 1000 HP Option
- Windlass Anchor

Additional key Sanpan Standards & Popular Options shown on pg 10



Comfortable stern Split Bench seating with a sleek fiberglass aft gate



	2700 SBW Twin	2700 SBC	2700 SBW	2500 SBC	2500 SBW	2300 SBC
MONACO						
LOA/Deck	27' 5" / 27' 4"	28' 1" / 27' 7"	28' 1" / 27' 7"	25' 9" / 25' 7"	25' 9" / 25' 7"	23' 11" / 23' 7"
Pontoon Length	26' 10"	26' 6"	26' 6"	24' 2"	24' 2"	22' 4"
Beam	8' 6"	8' 6"	8' 6"	8' 6"	8' 6"	8' 6"
Pontoon Diameter	29" iMPACT+	27" iMPACT	27" iMPACT	27" iMPACT	27" iMPACT	27" iMPACT
Fuel Capacity (GAL)	121	48	48	48	48	48
Person Capacity	11 - 16	14	14	16	16	13



[Click Here to Learn
More About the
Sanpan Mid Table Flip](#)

With the inviting comfort of a lounge and a spacious, stationary midship table designed for gathering, the Sanpan Mid Table Flip blends smooth, dynamic styling with a first-class interior, making it the ultimate setting for connection and relaxation.

SP 2500 MTF with Pacific Fiberglass Exterior & Riverstone Ultra Soft Furniture

SANPAN MID TABLE FLIP



Single Flip Lounge seating paired with a spacious stationary table for endless entertaining

SANPAN MID TABLE FLIP



Standard Equipment for Sanpan Mid Table Flip

- Single Flip Lounge Unit & Flip Seat for Co-Captain with Large, Stationary Table
- Fiberglass Stern Storage Cabinet
- Safety Barrier & Gate

Popular Options for Sanpan Mid Table Flip

- Sport Wave Bimini
- Grand Luxe Arch with Tower Speakers

Additional key Sanpan Standards & Popular Options shown on pg 10

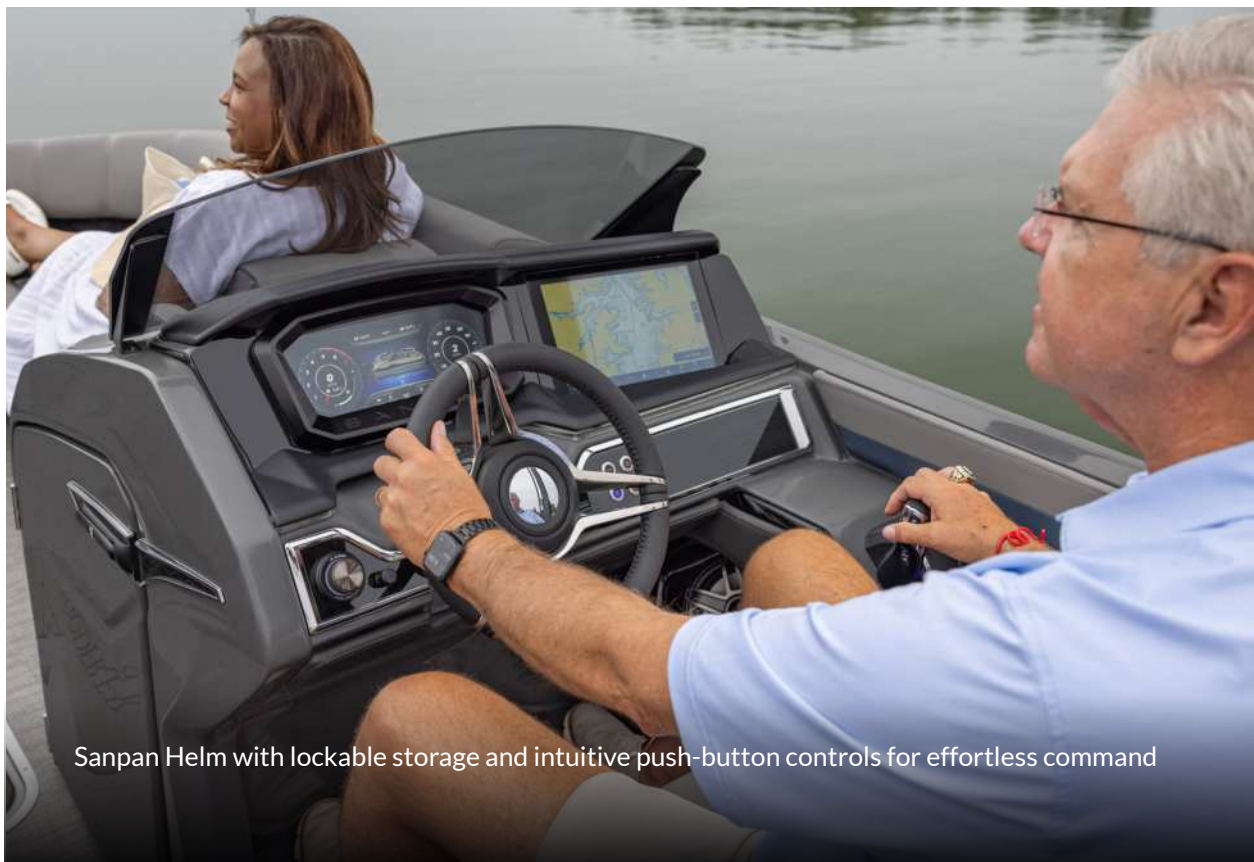

Sanpan Helm with lockable storage and intuitive push-button controls for effortless command



SANPAN	2700 MTF	2500 MTF
LOA/Deck	28' 1" / 27' 7"	25' 9" / 25' 7"
Pontoon Length	26' 6"	24' 2"
Beam	8' 6"	8' 6"
Pontoon Diameter	27" iMPACT	27" iMPACT
Fuel Capacity (GAL)	48	48
Person Capacity	14	16

AQUAPATIO

ELEVATE THE EXPERIENCE

From a day of watersports to sunset cruises and laughing it up with friends, make memories that last a lifetime on one of our Godfrey AquaPatio models. Combining superior performance with a sporty design and luxurious comfort, our AquaPatio series pulls out all the stops. Blur the lines between style and comfort while reinventing your definition of fun.

Make it last

Standard Equipment

- 27" iMPACT Triple Tube
27" Center Tube;
Two 25" Outer Tubes
(N/A Twin Models)
- Power Canopy
- 7" Multi-Function Display
(N/A Twin Models)
- Multi-Function GPS Gauges
- Clarion® Gold Audio System with
CMM-30 Head Unit, Six Channel
450W Amplifier, Six 6.5" RGB
Speakers & Chrome Sport Grilles
- Dual Battery Switch with Trays
- Reclining Captain's Chair
with Adjustable Pedestals
- Stainless Steel Comfort
Climb Ladder
- Integrated Navigation &
Docking Lights
- Wireless Phone Charger
- Bow & Stern USB A/C
Charging Ports
- Removable Table

Popular Options

- Powered Action Tower or Elite
Tower with Speakers
- JL® Audio System
- Full Spectrum RGB
Lighting Package
- Anchor Bracket for In-Floor Storage
- Lillipad® Ladder
- Ultimate Ski Tow Cage
- Stainless Steel Pull Up Cleats
- Protour Red or Eclipse Cool
Touch Furniture
- Scanstrut® ATMOS
Integrated Air Station
- 9" Multi-Functional Display
- Digital Gauges
- SeaView™ Bow Gate

*Escape and
adventure.*

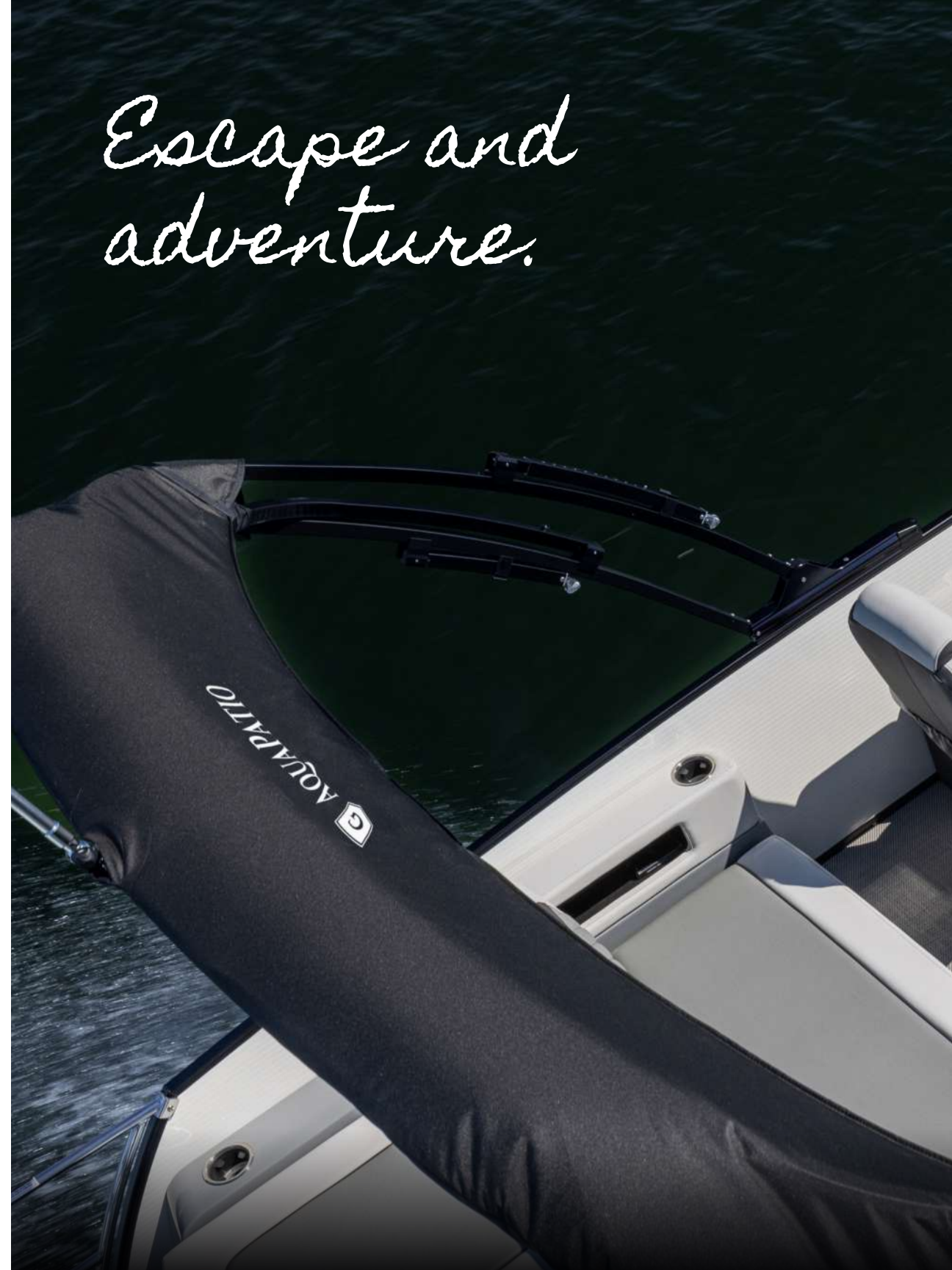



AP 235 SFLC with Metallic Pearl White Smooth Rail Skins & Bayside Slate Furniture



[Click Here to Learn More About the AquaPatio Twin](#)

Create unforgettable memories aboard one of our AquaPatio Twin models. Designed for durability and engineered to endure, our Twin models epitomize pontoon perfection.

AP 256 ULW Twin with Metallic Black Smooth Rail Skins, Carbon Fiber Graphics & Cognac Cool Touch Furniture

AQUAPATIO TWIN



AquaPatio Helm equipped with a 9" Multi-Function Display & Godfrey Digital Gauges for precision control

AQUAPATIO TWIN



Standard Equipment for AquaPatio Twin

- 29" iMPACT+ Triple Tube 29" Center Tube; Two 27" Outer Tubes
- 9" Multi-Function Display
- Godfrey Digital Gauges
- Removable Ski Tow Pylon
- Wireless Phone Charger
- Reclining Captain's & Co-Captain's Chairs
- Solid Keel Strips
- VSR Triple Battery System

Popular Options for AquaPatio Twin

- 350 - 600 HP Options
- Joystick Controls

Additional key AquaPatio Standards & Popular Options shown on pg 22



Command the water with Twin Engines delivering up to 600 HP of pure performance



AQUAPATIO

	256 SBC Twin	256 SBW Twin	256 ULC Twin	256 ULW Twin
LOA/Deck	25' 9" / 25' 4"	25' 9" / 25' 4"	25' 9" / 25' 4"	25' 9" / 25' 4"
Pontoon Length	25' 0"	25' 0"	25' 0"	25' 0"
Beam	8' 6"	8' 6"	8' 6"	8' 6"
Pontoon Diameter	29" iMPACT+	29" iMPACT+	29" iMPACT+	29" iMPACT+
Fuel Capacity (GAL)	121	121	121	121
Person Capacity	11 - 14	11 - 14	11 - 14	11 - 14



[Click Here to Learn
More About the
AquaPatio Windshield](#)

Relish every moment with your loved ones on our AquaPatio Windshield models. Our sleek, aerodynamic windshield allows you to stay dry and comfortable, making it a crowd favorite.

AP 255 SBW with Metallic Black Smooth Rail Skins

AQUAPATIO WINDSHIELD



Generous Split Bench seating for ultimate comfort and versatility

AQUAPATIO WINDSHIELD



Standard Equipment for AquaPatio Windshield

- Walk-Thru Low-Profile Windshield
- Port Helm with Co-Captain's Chair
- Lounge or Split Bench Layouts with the Protection of a Windshield

Popular Options for AquaPatio Windshield

- Windblock Curtain

Additional key AquaPatio Standards & Popular Options shown on pg 22



Sleek walk-thru Windshield for style & easy access

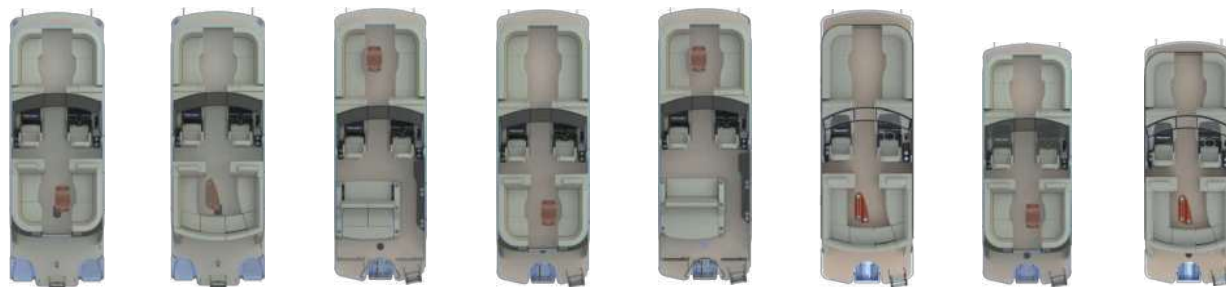

AQUAPATIO

	256 SBW Twin	256 ULW Twin	255 DFLW	255 SBW	255 SFLW	255 ULW	235 SBW	235 ULW
LOA/Deck	25' 9" / 25' 4"	25' 9" / 25' 4"	25' 9" / 25' 7"	25' 9" / 25' 7"	25' 9" / 25' 7"	25' 9" / 25' 7"	23' 11" / 23' 7"	23' 11" / 23' 7"
Pontoon Length	25' 0"	25' 0"	24' 2"	24' 2"	24' 2"	24' 2"	22' 4"	22' 4"
Beam	8' 6"	8' 6"	8' 6"	8' 6"	8' 6"	8' 6"	8' 6"	8' 6"
Pontoon Diameter	29" iMPACT+	29" iMPACT+	27" iMPACT	27" iMPACT	27" iMPACT	27" iMPACT	27" iMPACT	27" iMPACT
Fuel Capacity (GAL)	121	121	48	48	48	48	48	48
Person Capacity	11 - 14	11 - 14	16	16	16	16	13	13

AQUAPATIO ENTERTAINMENT



Standard Equipment for AquaPatio Entertainment

- Entertainment Center, Large Table with Four Bar Stools, & Grill Master on CBE Models
- Sink, Large Table with Bench Seats & Stainless Steel Gas Grill on MT Models

Popular Options for AquaPatio Entertainment

- Upgraded Bar Stools
- Double Bimini

Additional key AquaPatio Standards & Popular Options shown on pg 22



Grill Master featuring Stainless Steel Gas Grill



Built-In Faucet with Convenient Lid Cover



AQUAPATIO

	275 CBE	255 CBE	255 MT	235 MT
LOA/Deck	28' 1" / 27' 7"	25' 9" / 25' 7"	25' 9" / 25' 7"	23' 11" / 23' 7"
Pontoon Length	26' 6"	24' 2"	24' 2"	22' 4"
Beam	8' 6"	8' 6"	8' 6"	8' 6"
Pontoon Diameter	27" iMPACT	27" iMPACT	27" iMPACT	27" iMPACT
Fuel Capacity (GAL)	48	48	48	48
Person Capacity	14	16	16	13



Front Extension for Power Canopy for additional shade coverage



[Click Here to Learn
More About the
AquaPatio Entertainment](#)

AQUAPATIO ENTERTAINMENT

Turn every outing into a celebration with friends and family on one of our AquaPatio Entertainment models.

AP 255 MT with Metallic Pearl White Smooth Rail Skins & Pearl White Graphics



[Click Here to Learn
More About the
AquaPatio Sundeck](#)

Enjoy every moment with your favorite people on our AquaPatio Sundeck models, where you'll have fun in the sun every day you're out on the water.

AP 275 SDE with Metallic Pearl White Smooth Rail Skins, Carbon Fiber Graphics & Lunar Gray Furniture

**AQUAPATIO
SUNDECK**



Helm with 7" Multi-Function Display & optional Godfrey Digital Gauges



Stainless Steel Gas Grill for effortless outdoor cooking

AQUAPATIO SUNDECK



Standard Equipment for AquaPatio Sundeck

- 29" iMPACT+ Triple Tube 29" Center Tube; Two 27" Outer Tubes
- Sink, Large Table with Bench Seats & Stainless Steel Gas Grill on SDE Models
- Slide Tower

Popular Options for AquaPatio Sundeck

- Flooring options on Tower Upper Deck
- Black Tower Frame

Additional key AquaPatio Standards & Popular Options shown on pg 22



Conversation-Friendly stern table with comfortable seating



AQUAPATIO

	275 SDC	275 SDE	255 SDC	255 SDE
LOA/Deck	28' 1" / 27' 7"	28' 1" / 27' 7"	25' 9" / 25' 7"	25' 9" / 25' 7"
Pontoon Length	26' 6"	26' 6"	24' 2"	24' 2"
Beam	8' 6"	8' 6"	8' 6"	8' 6"
Pontoon Diameter	29" iMPACT+	29" iMPACT+	29" iMPACT+	29" iMPACT+
Fuel Capacity (GAL)	63	63	63	63
Person Capacity	17	17	18	18

AQUAPATIO LOUNGE



Standard Equipment for AquaPatio Lounge

- Convertible Seating on DFL & SFL Models
- Stainless Steel Safety Barrier with Gate & Stern Storage Cabinet for DFL & SFL Models
- Fiberglass Stern Storage Cabinet on DFL & SFL Models
- Rectangular Table on DFL & SFL Models
- Triangular Table on UL Models

Popular Options

- Twin Models 350 HP - 600 HP Options
- Sport Wave Bimini

Additional key AquaPatio Standards & Popular Options shown on pg 22



Unwind in style with stern Ultra Lounge seating



Easily face forward or backward with the stern Single Flip Lounge seating



AQUAPATIO

	256 ULC Twin	256 ULW Twin	275 DFL	275 SFL	255 DFL	255 DFLW	255 SFL	255 SFLW	255 ULC	255 ULW	235 DFLC	235 SFLC	235 ULC	235 ULW
LOA/Deck	25' 9" / 25' 4"	25' 9" / 25' 4"	28' 1" / 27' 7"	28' 1" / 27' 7"	25' 9" / 25' 7"	25' 9" / 25' 7"	25' 9" / 25' 7"	25' 9" / 25' 7"	25' 9" / 25' 7"	25' 9" / 25' 7"	23' 11" / 23' 7"	23' 11" / 23' 7"	23' 11" / 23' 7"	23' 11" / 23' 7"
Pontoon Length	25' 0"	25' 0"	26' 6"	26' 6"	24' 2"	24' 2"	24' 2"	24' 2"	24' 2"	24' 2"	22' 4"	22' 4"	22' 4"	22' 4"
Beam	8' 6"	8' 6"	8' 6"	8' 6"	8' 6"	8' 6"	8' 6"	8' 6"	8' 6"	8' 6"	8' 6"	8' 6"	8' 6"	8' 6"
Pontoon Diameter	29" iMPACT+	29" iMPACT+	27" iMPACT	27" iMPACT	27" iMPACT	27" iMPACT	27" iMPACT	27" iMPACT	27" iMPACT	27" iMPACT	27" iMPACT	27" iMPACT	27" iMPACT	27" iMPACT
Fuel Capacity (GAL)	121	121	48	48	48	48	48	48	48	48	48	48	48	48
Person Capacity	11 - 14	11 - 14	14	14	16	16	16	16	16	16	13	13	13	13



[Click Here to Learn
More About the
AquaPatio Lounge](#)

AQUAPATIO LOUNGE

A variety of seating and lounging capabilities allow you to chill during the heat of the day and cruise the sunset after.

AP 235 DFCL with Matte Black Smooth Rail Skins, Carbon Fiber Graphics & Protour Red Furniture



[Click Here to Learn
More About the
AquaPatio Split Bench](#)

Spacious and comfortable, our AquaPatio Split Bench models are available in 21 to 25-foot lengths with plentiful seating and an open center-deck from bow to stern.

AP 256 Twin with Charcoal Smooth Rail Skins, Slate Graphics & Bayside Slate Furniture

AQUAPATIO SPLIT BENCH



Helm featuring 7" Multi-Function Display, Multi-Function GPS Gauges, optional storage locker & more for seamless navigation & convenience

AQUAPATIO SPLIT BENCH



Standard Equipment for AquaPatio Split Bench

- Bow & Stern Quad Benches for Storage & Comfortable Seating
- Rectangular Table
- With or without Co-Captain's Seat

Popular Options for AquaPatio Split Bench

- Elite Tower with Tower Speakers

Additional key AquaPatio Standards & Popular Options shown on pg 22

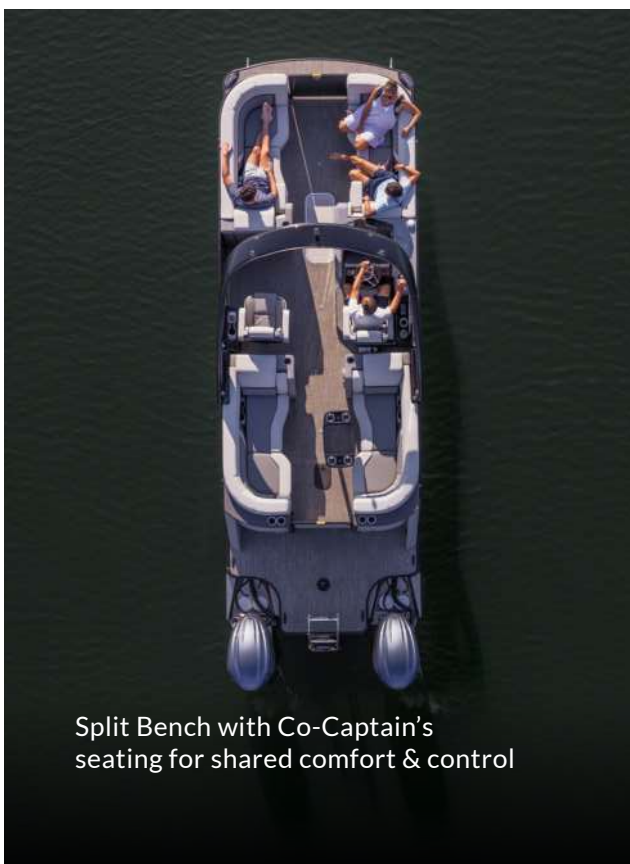

Split Bench with Co-Captain's seating for shared comfort & control

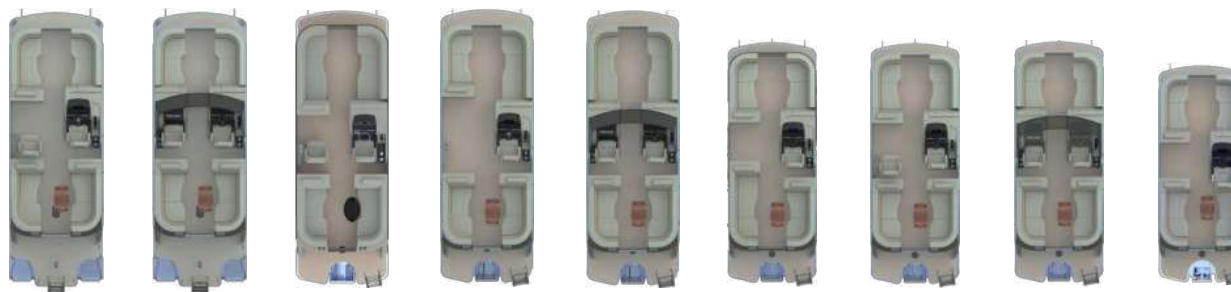

AQUAPATIO

	256 SBC Twin	256 SBW Twin	255 SBC	255 SBH	255 SBW	235 SB	235 SBC	235 SBW	215 SB
LOA/Deck	25' 9" / 25' 4"	25' 9" / 25' 4"	25' 9" / 25' 7"	25' 9" / 25' 7"	25' 9" / 25' 7"	23' 11" / 23' 7"	23' 11" / 23' 7"	23' 11" / 23' 7"	21' 11" / 21' 7"
Pontoon Length	25' 0"	25' 0"	24' 2"	24' 2"	24' 2"	22' 4"	22' 4"	22' 4"	20' 4"
Beam	8' 6"	8' 6"	8' 6"	8' 6"	8' 6"	8' 6"	8' 6"	8' 6"	8' 6"
Pontoon Diameter	29" iMPACT+	29" iMPACT+	27" iMPACT	27" iMPACT	27" iMPACT	27" iMPACT	27" iMPACT	27" iMPACT	27" iMPACT
Fuel Capacity (GAL)	121	121	48	48	48	48	48	48	48
Person Capacity	11 - 14	11 - 14	16	16	16	13	13	13	13

MONACO

A LASTING LEGACY

Elevate your time on the water with the Godfrey Monaco Series, where timeless design meets enhanced finishes. Experience a flow-through layout and expansive, versatile seating configurations that deliver unmatched comfort. From smart extras to premium furniture, the Monaco Series is designed to impress with intuitive layouts and refined styling. Discover a pontoon experience that blends enduring craftsmanship with modern elegance, because on a Godfrey, every moment matters.

Make it Last

Standard Equipment

- 25" Outer Tubes
- Fiberglass Helm with Elevated Platform, Storage & Trash Receptacle on Helm Door
- Power Canopy
- 5" Fishfinder /Chartplotter Display
- Clarion® Silver Audio System with CMM-30 Head Unit, Four 6.5" Speakers & Black Sport Grilles
- Click & Cruise Rail Technology
- Glass Windscreen
- LED Docking Lights
- Stainless Steel Telescoping Ladder
- USB A/C Charging Ports
- Multi-Function GPS Gauges
- Playpen Cover
- SeaView™ Bow Gate

Popular Options

- Performance, Sport Tube or Triple Tube Packages
- 7" Multi-Functional Display
- Clarion® Gold or JL® Audio Systems
- Full Spectrum RGB Lighting Package
- Elite Tower with Tower Speakers
- Sport Wave Bimini
- Stainless Steel Comfort Climb Ladder or Lillipad® Ladder
- Back Porch Package adding two feet off Stern
- EZ Lift Manual Double Canopy
- Ultimate Ski Tow
- Upgraded Steering Wheel

*Versatility
in design.*





MC 275 QSL with Metallic Pearl White Smooth Rail Skins, Carbon Fiber Graphics Package, Elite Tower & Slate Ultra Soft Furniture



[Click Here to Learn
More About the
Monaco Lounge](#)

**Soak up the sun and make every moment count aboard the Monaco Lounge models,
where relaxation meets style for unforgettable days with family and friends.**

MC 235 ULC + Back Porch with Silver Matte Smooth Rail Skins, Carbon Fiber Graphics Package & Slate Ultra Soft Furniture

**MONACO
LOUNGE**



Stern Ultra Lounge seating combines premium comfort with a sleek design for ultimate relaxation, while the Click & Cruise Flagpole Kit adds a personalized touch to your boat when you're out on the water

MONACO LOUNGE



Standard Equipment for Monaco Lounge

- Comfort of Three Additional Seats Plus the Captain's Seat with Single Flip Lounge Layout on QSL
- Single Flip Lounge Layout with Various Seating Configurations on SFL Models
- Spacious U-Shaped Design with a Stern Table on ULC Models
- Stainless Steel Safety Barrier Gate on SFL & QSL Models
- Ultimate Ski Tow Cage on SFL & QSL Models

Popular Options for Monaco Lounge

- Upgraded Rectangular Table

Additional key Monaco Standards & Popular Options shown on pg 36



Monaco Helm featuring 7" Multi-Function display, push button controls & more for a seamless boating experience



MONACO	275 QSL	255 SFL	255 SFLC	255 ULC	235 SFL	235 SFLC	235 ULC
LOA/Deck	28' 1" / 27' 7"	25' 9" / 25' 7"	25' 9" / 25' 7"	25' 9" / 25' 7"	23' 11" / 23' 7"	23' 11" / 23' 7"	23' 11" / 23' 7"
Pontoon Length	26' 6"	24' 2"	24' 2"	24' 2"	22' 4"	22' 4"	22' 4"
Beam	8' 6"	8' 6"	8' 6"	8' 6"	8' 6"	8' 6"	8' 6"
Pontoon Diameter	27" iMPACT	25" 2 Tube	25" 2 Tube	25" 2 Tube	25" 2 Tube	25" 2 Tube	25" 2 Tube
Fuel Capacity (GAL)	48	30	30	30	30	30	30
Person Capacity	14	14	14	14	12	12	12



[Click Here to Learn More About the Monaco Quad Social](#)

With multiple seating zones and open space, the Monaco Quad Social models are built for connection, sharing laughs, and cruising into unforgettable memories.

MC 275 QSL with Metallic Pearl White Smooth Rail Skins, Carbon Fiber Graphics Package & Slate Ultra Soft Furniture

MONACO QUAD SOCIAL



Relax in the comfort of four Captain's Chairs on the new SBQ model

MONACO QUAD SOCIAL



Standard Equipment for Monaco Quad Social

- Comfort of Three Additional Seats Plus the Captain's Seat
- Additional Lounger on QSL Model
- Oval Removable Table with Built-In Cupholders
- Stainless Steel Safety Barrier Gate on QSL
- Ultimate Ski Tow Cage on QSL
- Toy Box Storage on Stern Platform on QSB

Popular Options for Monaco Quad Social

- Upgraded Removable Rectangle Table with Stainless Steel Cupholders
- Bow Filler Seat

Additional key Monaco Standards & Popular Options shown on pg 36



Gather comfortably on the QSB, in the helm seats or stretching out on a bench seat



MONACO	275 SBQ	275 QSL	255 QS	255 QSB	235 QS	235 QSB
LOA/Deck	28' 1" / 27' 7"	28' 1" / 27' 7"	25' 9" / 25' 7"	25' 9" / 25' 7"	23' 11" / 23' 7"	23' 11" / 23' 7"
Pontoon Length	26' 6"	26' 6"	24' 2"	24' 2"	22' 4"	22' 4"
Beam	8' 6"	8' 6"	8' 6"	8' 6"	8' 6"	8' 6"
Pontoon Diameter	27" iMPACT	27" iMPACT	25" 2 Tube	25" 2 Tube	25" 2 Tube	25" 2 Tube
Fuel Capacity (GAL)	48	48	30	30	30	30
Person Capacity	14	14	14	14	12	12



[Click Here to Learn
More About the
Monaco Sundeck](#)

Simply too much fun for one, spend a day making boating memories on our one-of-a-kind Monaco Sundeck models featuring a center walkthrough design, rear water slide and optional midship bar layout.

MC 235 SDC with Pacific Smooth Rail Skins, Charcoal Top Graphic & Granite Soft Touch Furniture

**MONACO
SUNDECK**



Crafted for comfort, stretch out on one of the bow Split Bench seats aboard the new MC SDC

MONACO SUNDECK



Standard Equipment for Monaco Sundeck

- 29" iMPACT+ Triple Tube 29" Center Tube; Two 27" Outer Tubes
- Bow and Stern Quad Benches with Oval Removable Table on SD & SDC Models
- Solid Surface Bar Top with Cupholders, Bar Stools with Sliders & Footrests & 15-19" Adjustable Pedestals on SDB Models
- Slide Tower

Popular Options for Monaco Sundeck

- Slide Tower Front Canopy to Add More Shade Coverage
- Upgraded Deluxe Bar Stools on SDB Models
- Removable Rectangle Table with Stainless Steel Cupholders (N/A SDB Models)
- Upper Deck Flooring

Additional key Monaco Standards & Popular Options shown on pg 36

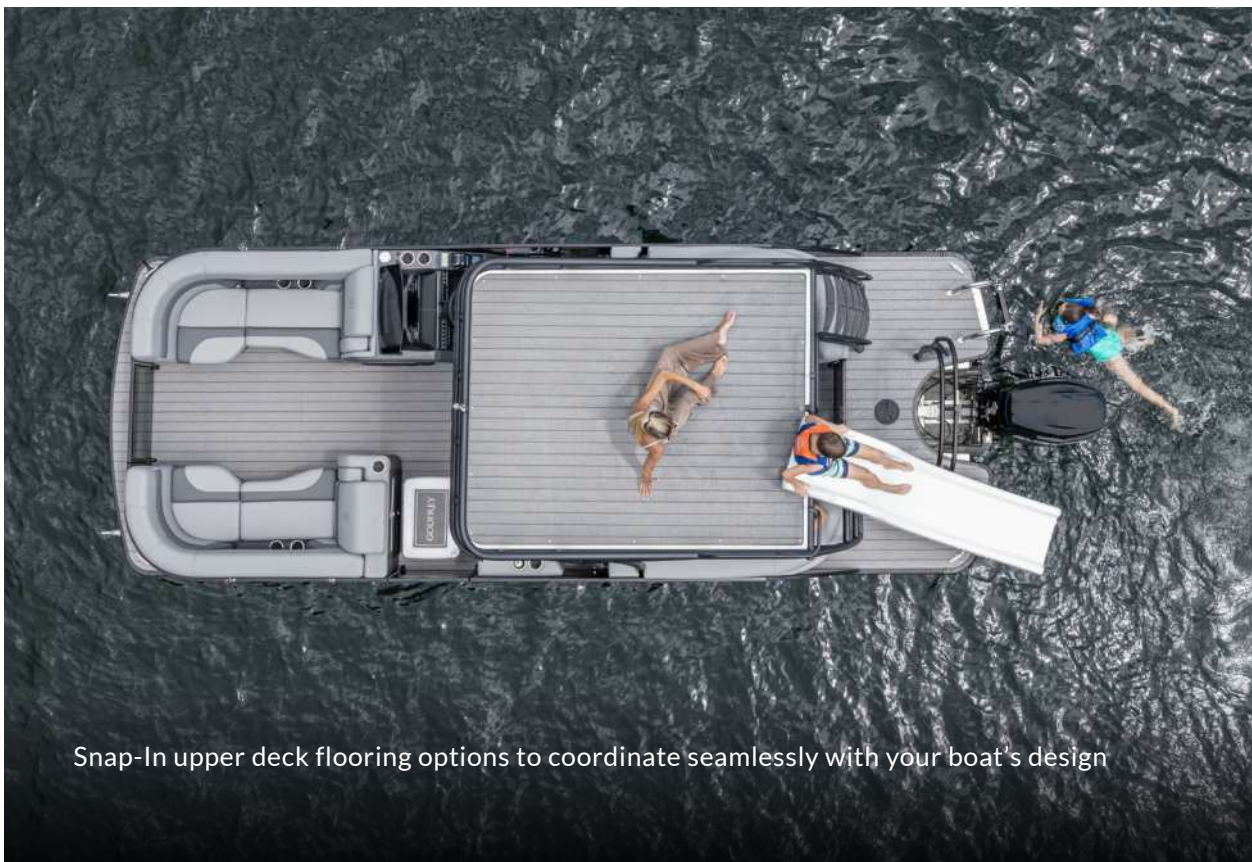

Snap-In upper deck flooring options to coordinate seamlessly with your boat's design



MONACO

	255 SD	255 SDB	255 SDC	235 SDB	235 SDC
LOA/Deck	25' 9" / 25' 7"	25' 9" / 25' 7"	25' 9" / 25' 7"	23' 11" / 23' 7"	23' 11" / 23' 7"
Pontoon Length	24' 2"	24' 2"	24' 2"	22' 4"	22' 4"
Beam	8' 6"	8' 6"	8' 6"	8' 6"	8' 6"
Pontoon Diameter	29" iMPACT+	29" iMPACT+	29" iMPACT+	29" iMPACT+	29" iMPACT+
Fuel Capacity (GAL)	63	63	63	63	63
Person Capacity	18	18	18	16	16



GODFREY

[Click Here to Learn More About the Monaco Split Bench](#)

The flow-through design and expansive, versatile seating configuration of our Monaco Split Bench models are available in lengths from 21 to 25-feet.

MC 255 QSB with Sage Smooth Rail Skins, White Bottom Graphic & Latte Ultra Soft Touch Furniture

MONACO SPLIT BENCH



Enhance your layout with the optional bow filler seat for ultimate flexibility & comfort

MONACO SPLIT BENCH



Standard Equipment for Monaco Split Bench

- Bow & Stern Quad Benches for Storage & Comfortable Seating
- Comfort of Three Additional Seats Plus the Captain's Seat on SBQ
- Oval Removable Table with Built-In Cupholders

Popular Options for Monaco Split Bench

- Removable Rectangle Table with Stainless Steel Cupholders

Additional key Monaco Standards & Popular Options shown on pg 36



Standard trash receptacle at the Monaco Helm for quick & convenient disposal



MONACO	275 SBQ	255 SB	255 SBC	235 SB	235 SBC	215 SB	215 SBC
LOA/Deck	28' 1" / 27' 7"	25' 9" / 25' 7"	25' 9" / 25' 7"	23' 11" / 23' 7"	23' 11" / 23' 7"	23' 10" / 22' 1"	23' 10" / 23' 5"
Pontoon Length	26' 6"	24' 2"	24' 2"	22' 4"	22' 4"	22' 4"	22' 4"
Beam	8' 6"	8' 6"	8' 6"	8' 6"	8' 6"	8' 6"	8' 6"
Pontoon Diameter	27" iMPACT	25" 2 Tube	25" 2 Tube	25" 2 Tube	25" 2 Tube	25" 2 Tube	25" 2 Tube
Fuel Capacity (GAL)	48	30	30	30	30	30	30
Person Capacity	14	14	14	12	12	12	12

MONACO CRUISE

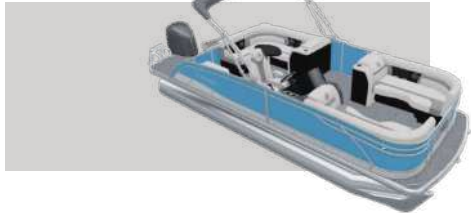

Standard Equipment for Monaco Cruise

- Bow Benches for Storage & Comfortable Seating with Stern L-Bench Seating
- Oval Removable Table with Built-In Cupholders
- Toy Box Storage on Stern Platform

Popular Options for Monaco Cruise

- Removable Rectangle Table with Stainless Steel Cupholders
- Bolster Helm Seat
- Chaise Changing Room

Additional key Monaco Standards & Popular Options shown on pg 36



Co-Captain's seating featuring cupholders for optimal comfort



SeaView™ Bow Gate, giving your furry friends a front row view to the open waters

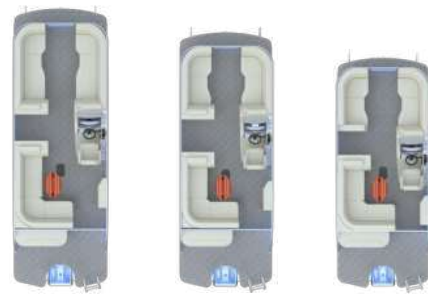

MONACO	255 C	235 C	215 C
LOA/Deck	25' 9" / 25' 7"	23' 11" / 23' 7"	23' 10" / 22' 1"
Pontoon Length	24' 2"	22' 4"	22' 4"
Beam	8' 6"	8' 6"	8' 6"
Pontoon Diameter	25" 2 Tube	25" 2 Tube	25" 2 Tube
Fuel Capacity (GAL)	30	30	30
Person Capacity	14	12	12



Fiberglass Helm with standard Glass Windscreen and Wireless Phone Charger



[Click Here to Learn More About the Monaco Cruise](#)

MONACO CRUISE

Versatile and stylish, our 21 to 27-foot Monaco Cruise models offer room for more with L-shaped seating, a table to gather with friends and an extended stern swim platform.

MC 235 C + Back Porch with Pacific Smooth Rail Skins & Dune Soft Touch Furniture

MONACO MID TABLE FLIP



Standard Equipment for Monaco Mid Table Flip

- Single Flip Lounge Layout & Flip Seat or Bar Stools for Co-Captain with Large, Stationary Table
- Stainless Steel Safety Barrier Gate
- Ultimate Ski Tow Cage

Popular Options for Monaco Mid Table Flip

- Stern Toy Storage Box
- Sport Wave Bimini

Additional key Monaco Standards & Popular Options shown on pg 36



Ample space for family meals or hosting game night comes standard



MONACO	275 MTF	255 MTF	235 MTF
LOA/Deck	28' 1" / 27' 7"	25' 9" / 25' 7"	23' 11" / 23' 7"
Pontoon Length	26' 6"	24' 2"	22' 4"
Beam	8' 6"	8' 6"	8' 6"
Pontoon Diameter	27" iMPACT	25" 2 Tube	25" 2 Tube
Fuel Capacity (GAL)	48	30	30
Person Capacity	14	14	12

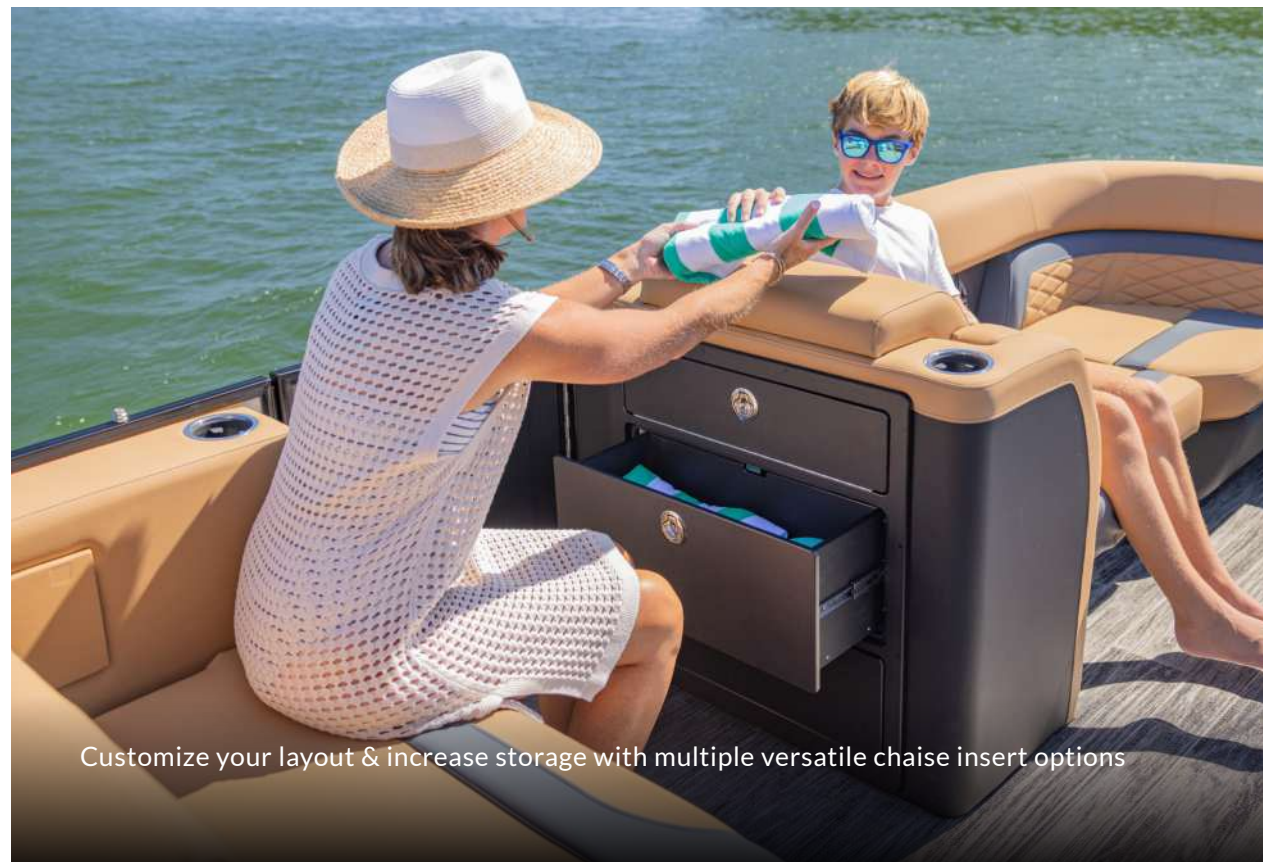

Customize your layout & increase storage with multiple versatile chaise insert options



[Click Here to Learn
More About the
Monaco Mid Table Flip](#)

MONACO MID TABLE FLIP

The convenience of a large table, mixed with the versatile seating configuration of our Monaco Mid Table Flip models are available in lengths from 23 to 27-feet.

MC 255 MTF with Charcoal Smooth Rail Skins & Cognac Cool Touch Furniture with Anchor Gray Accent Color



Live, laugh, relax



Family time



Life on the water



Lake days



Simple pleasures



Living the good life



Days like these



Dog days of summer



Paradise found



Summer days

Make it last.

SWEETWATER

UNBELIEVABLE VERSATILITY

Chart a course for laughter and good times with friends and family aboard our Sweetwater series. These action-packed pontoons are perfect for any family who wants to spend time together on the water. Offering an unforgettable experience at a fantastic value, our pontoons blend modern performance touches with classic styling for a difference you can see and feel.

Make it last.

Standard Equipment

- 25" Outer Tubes
- Power Canopy
- Click & Cruise Rail Technology
- Clarion® Plus Audio System with CMM-10 Head Unit, 4x20W RMS Output & Four 6.5" Speakers with Gray Grilles
- Silver EZ Climb Ladder
- Playpen Cover
- Fixed Stainless Steel Cleats & Silver Corner Castings
- Interior Courtesy Light

Popular Options

- Performance, Sport Tube or Triple Tube Package
- Clarion® Color or Color Plus Audio System with Upgraded Head Unit & RGB Speakers
- Full Spectrum RGB Lighting Package or Interior-only RGB Package
- Ultimate Ski Tow Cage
- Windscreen
- LED Docking Lights
- Stainless Steel Package
- Multiple Chaise Insert Storage Solutions: Folding Table, Three Drawer, Tilt Out Trash Can, Tackle Storage & Table with Dog Bowl
- Front Extension for Power or Manual Canopy to add More Shade Coverage
- Upgraded Steering Wheel
- Movable Cupholders



*Pursue your
passion.*

SW 2286 QS with Atlas Gray Furniture, Lagoon Accent Color & Driftwood Cool Touch Flooring

SWEETWATER LOUNGE



Standard Equipment for Sweetwater Lounge

- Single Flip Lounge Layout with Various Seating Configurations
- Models with or without Co-Captain's Seat
- Ultimate Ski Tow
- Stern Toy Storage Box
- Stainless Steel Safety Barrier Gate
- Round Table with Built-In Cupholders

Popular Options for Sweetwater Lounge

- Recliner Helm Seat
- Changing Room in SFL Unit

Additional key Sweetwater Standards & Popular Options shown on pg 52



Standard Helm equipped with classic analog gauges for precise control

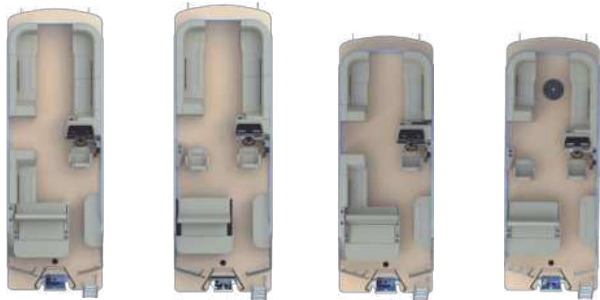

SWEETWATER

	2486 SFL	2486 SFLC	2286 SFL	2286 SFLC
LOA/Deck	25' 9" / 25' 6"	25' 9" / 25' 6"	23' 10" / 23' 5"	23' 10" / 23' 5"
Pontoon Length	24' 2"	24' 2"	22' 4"	22' 4"
Beam	8' 6"	8' 6"	8' 6"	8' 6"
Pontoon Diameter	25" 2 Tube	25" 2 Tube	25" 2 Tube	25" 2 Tube
Fuel Capacity (GAL)	30	30	30	30
Person Capacity	14	14	12	12



Stainless Steel Bi-Fold Gate opens both inward & outward for easy access & versatility



[Click Here to Learn More About the Sweetwater Lounge](#)

SWEETWATER LOUNGE

Our Sweetwater Lounge models extend the best days of the seasons with versatility, comfort and features tailor-made for relaxation.

SW 2486 SFLC with Black Smooth Rail Skins, Sunburst Low-Band Graphics & Eclipse Cool Touch Furniture with Sunburst Accent Color

SWEETWATER ENTERTAINMENT



Standard Equipment for Sweetwater Entertainment

- Two Flip Seats with Telescoping Table Transforming into large bed on DT Models
- Solid Surface Bar Top with Cupholders, Two Bar Stools with Sliders & Footrests on MT Models
- Ultimate Ski Tow on DT Models
- Stainless Steel Safety Barrier Gate on DT Models
- Entertainment Center with Built-In Sink with Hand Pump & 15-19" Adjustable Pedestals on MT Models
- Fastback Rails

Popular Options for Sweetwater Entertainment

- Upgraded Bar Stools for MT Models
- Recliner Helm Seat

Additional key Sweetwater Standards & Popular Options shown on pg 52

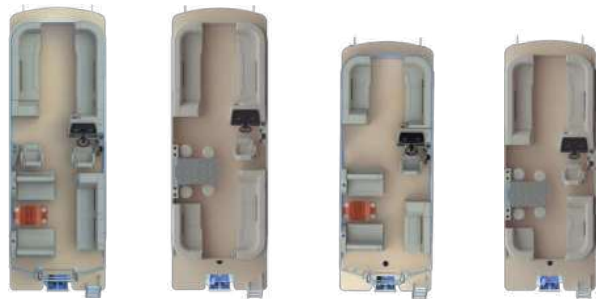

SWEETWATER

	2486 DT	2486 MT	2286 DT	2286 MT
LOA/Deck	25' 9" / 25' 6"	25' 9" / 25' 6"	23' 10" / 23' 5"	23' 10" / 23' 5"
Pontoon Length	24' 2"	24' 2"	22' 4"	22' 4"
Beam	8' 6"	8' 6"	8' 6"	8' 6"
Pontoon Diameter	25" 2 Tube	25" 2 Tube	25" 2 Tube	25" 2 Tube
Fuel Capacity (GAL)	30	30	30	30
Person Capacity	14	14	12	12



Transform your space with the DT telescoping table and Stern Flip Seats, creating a large flat lounge or adjusting the Flip Seats to any angle for ultimate comfort

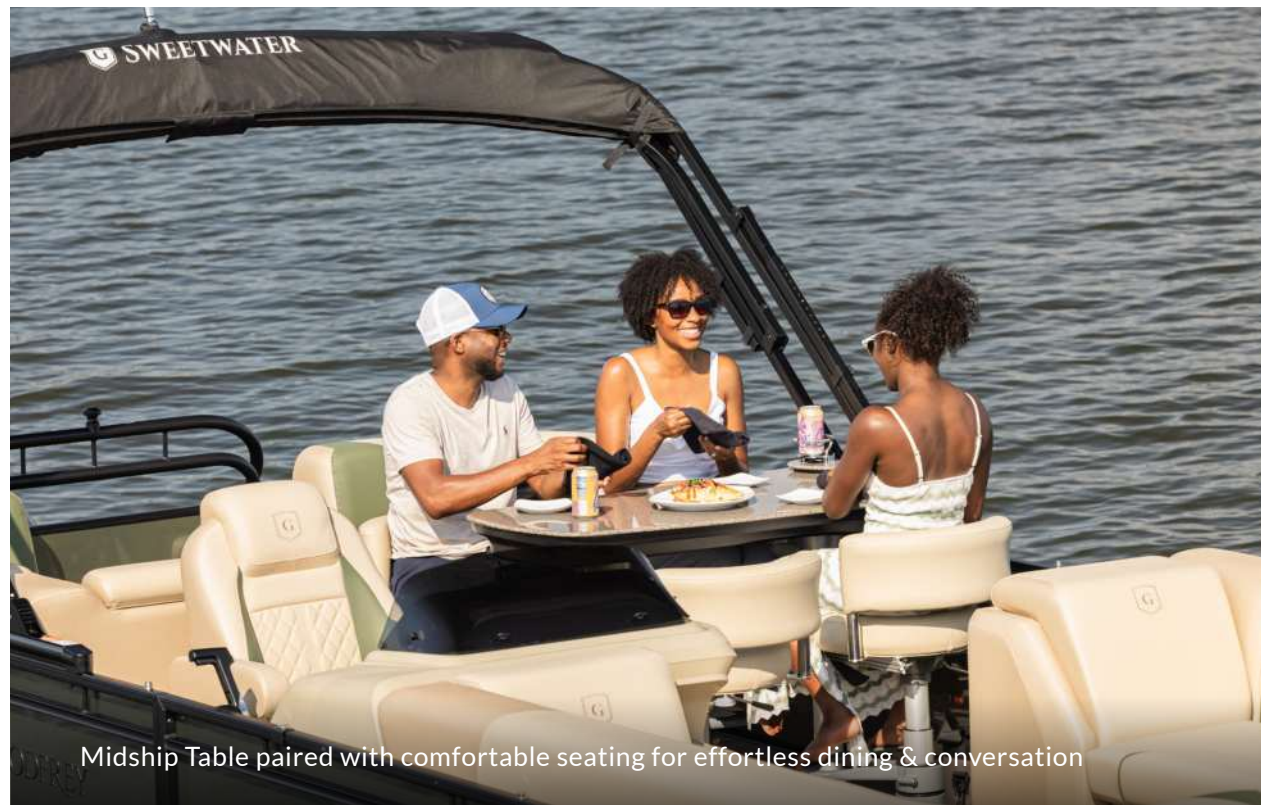

Midship Table paired with comfortable seating for effortless dining & conversation



[Click Here to Learn
More About the
Sweetwater Entertainment](#)

SWEETWATER ENTERTAINMENT

Set sail for laughter and great times with loved ones on our Sweetwater Entertainment models. Enjoy the perfect mix of lounge seating, wet bar, and table options.

SW 2286 MT with Sage Smooth Rail Skins, Black Low-Band Graphics & Sienna Beige Furniture with Sage Accent Color



[Click Here to Learn
More About the
Sweetwater Quad Social](#)

It's easy to catch up with family and friends on the Quad Social layouts - or stretch out on the Bow Benches to relax on your own.

SW 2286 QS with Lagoon Smooth Rail Skins, Carbon Fiber Low-Band Graphics & Atlas Gray Furniture with Lagoon Accent Color

**SWEETWATER
QUAD SOCIAL**



Helm featuring Analog Gauges and Clarion® Stereo for reliable control & superior sound

SWEETWATER QUAD SOCIAL



Standard Equipment for Sweetwater Quad Social

- Comfort of Three Additional Seats Plus the Captain's Seat
- Fastback Rails
- Round Table with Built-In Cupholders

Popular Options for Sweetwater Quad Social

- Removable Rectangle Table with Stainless Steel Cupholders

Additional key Sweetwater Standards & Popular Options shown on pg 52



Add extra comfort with the optional filler seat at the bow or stern gates for more seating flexibility

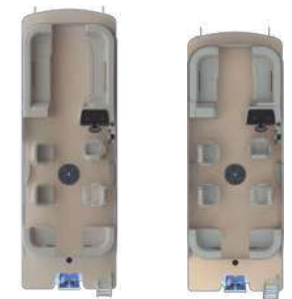

SWEETWATER

	2486 QS	2286 QS
LOA/Deck	25' 9" / 25' 6"	23' 10" / 23' 5"
Pontoon Length	24' 2"	22' 4"
Beam	8' 6"	8' 6"
Pontoon Diameter	25" 2 Tube	25" 2 Tube
Fuel Capacity (GAL)	30	30
Person Capacity	14	12

SWEETWATER SPLIT BENCH



Standard Equipment for Sweetwater Split Bench

- Bow & Stern Quad Benches for Storage and Comfortable Seating
- Fastback Rails
- Center Walk-Thru

Popular Options for Sweetwater Split Bench

- Upgraded Recliner Helm Seat
- Back Porch

Additional key Sweetwater Standards & Popular Options shown on pg 52



Optional tilt-out trash can chaise insert for convenient waste storage

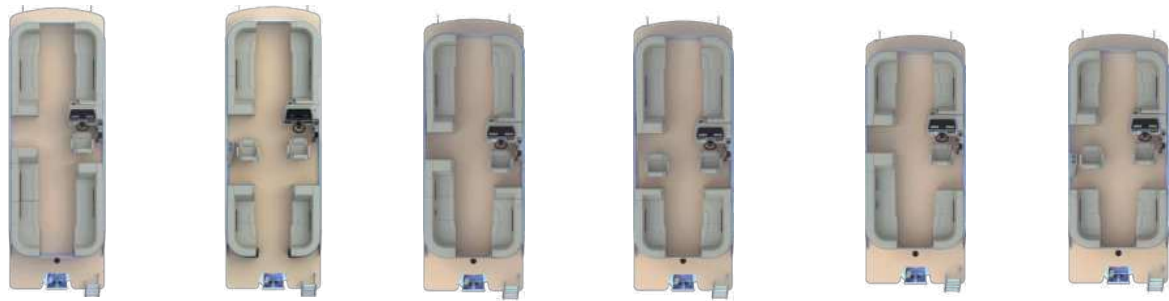

SWEETWATER

	2486 SB	2486 SBC	2286 SB	2286 SBC	2086 SB	2086 SBC
LOA/Deck	25' 9" / 25' 6"	25' 9" / 25' 6"	23' 10" / 23' 5"	23' 10" / 23' 5"	21' 10" / 21' 5"	21' 10" / 21' 5"
Pontoon Length	24' 2"	24' 2"	22' 4"	22' 4"	20' 4"	20' 4"
Beam	8' 6"	8' 6"	8' 6"	8' 6"	8' 6"	8' 6"
Pontoon Diameter	25" 2 Tube	25" 2 Tube	25" 2 Tube	25" 2 Tube	25" 2 Tube	25" 2 Tube
Fuel Capacity (GAL)	30	30	30	30	30	30
Person Capacity	14	14	12	12	11	11



Optional Back Porch Package adds two extra feet off the stern for more space & comfort



[Click Here to Learn
More About the
Sweetwater Split Bench](#)

SWEETWATER SPLIT BENCH

With comfortable seating from bow to stern in lengths from 21 to 24-feet, the Sweetwater Split Bench brings more families together.

SW 2286 SB with Crimson Smooth Rail Skins, Black Low-Band Graphics & Sienna Beige Furniture with Crimson Accent Color



[Click Here to Learn
More About the
Sweetwater Cruise](#)

Step aboard, kick back, and enjoy the comfort that only a Sweetwater Cruise can deliver.

SW 2086 C with Silver Matte Smooth Rail Skins, Carbon Fiber Low-Band Graphics, Moonstone Mid-Body Graphics & Select Gray Furniture with Anchor Gray Accent Color

SWEETWATER CRUISE



Helm featuring optional 5" Chartplotter/Fishfinder, standard Analog Gauges, upgraded Steering Wheel & more for precision control & functionality

SWEETWATER CRUISE



Standard Equipment for Sweetwater Cruise

- Bow Benches for Storage & Comfortable Seating with Stern L-Bench Seating
- Round Table with Built-In Cupholders
- Fastback Rails

Popular Options for Sweetwater Cruise

- Back Porch
- Toy Storage Box

Additional key Sweetwater Standards & Popular Options shown on pg 52

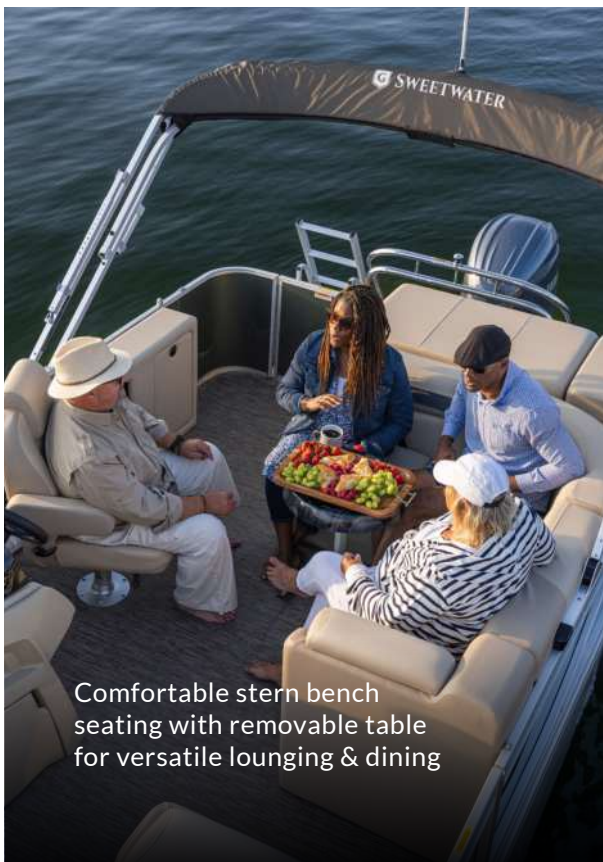

Comfortable stern bench seating with removable table for versatile lounging & dining

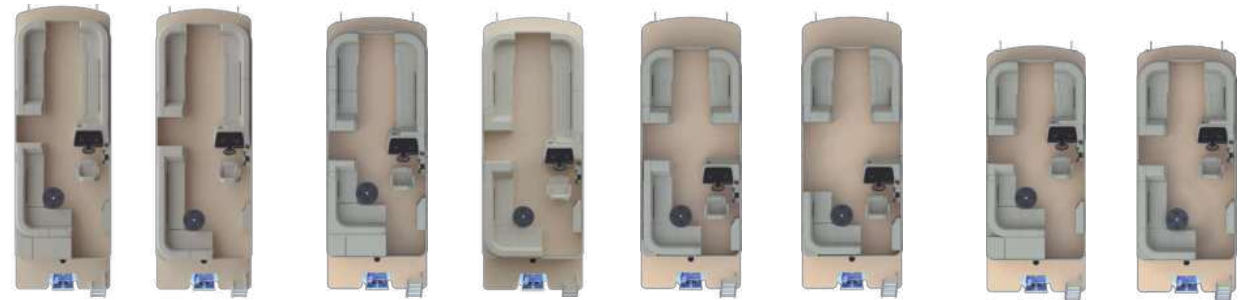

SWEETWATER

	2486 C	2486 CP	2286 C	2286 CP	2286 C4	2286 C4H	2086 C	2086 CP
LOA/Deck	25' 9" / 25' 6"	25' 9" / 25' 6"	23' 10" / 23' 5"	23' 10" / 23' 5"	23' 10" / 23' 5"	23' 10" / 23' 5"	21' 10" / 21' 5"	21' 10" / 21' 5"
Pontoon Length	24' 2"	24' 2"	22' 4"	22' 4"	22' 4"	22' 4"	20' 4"	20' 4"
Beam	8' 6"	8' 6"	8' 6"	8' 6"	8' 6"	8' 6"	8' 6"	8' 6"
Pontoon Diameter	25" 2 Tube	25" 2 Tube	25" 2 Tube	25" 2 Tube	25" 2 Tube	25" 2 Tube	25" 2 Tube	25" 2 Tube
Fuel Capacity (GAL)	30	30	30	30	30	30	30	30
Person Capacity	14	14	12	12	12	12	11	11



[Click Here to Learn More About the Sweetwater Fishing](#)

The Sweetwater Fishing models combine the treasured gift of family and your passion to fish in a pontoon where versatility, value and long-lasting quality come together.

SW 2086 F with Moonstone Smooth Rail Skins, Pacific Low-Band Graphics & Select Gray Furniture with Pacific Accent

SWEETWATER FISHING



Bow Fish layout with two optional upgraded fishing seats for added comfort

SWEETWATER FISHING



Standard Equipment for Sweetwater Fishing

- Bow or Stern Fish Seats
- Stern Fiberglass Fish Prep Station on F & FS Models, Includes: Sink with Transom Shower Faucet, 16.5 Gallon Aerated Livewell, Tackle Box with Plano Box Storage, Rod Holders & Trash Can
- Power Canopy (N/A 2086 BF)
- Rod Holders & Lockable Storage Box
- Trolling Motor Harness Kit with Plug & Half Gate on F & FS Models
- Livewell
- Round Table with Built-In Cupholders

Popular Options for Sweetwater Fishing

- Deluxe Fish Seats

Additional key Sweetwater Standards & Popular Options shown on pg 52



Experience maximum fun on the water with our Fish Layout, featuring four total fish seats



2286 BF



2286 F



2286 FS



2086 BF



2086 F



2086 FS

SWEETWATER

	2286 BF	2286 F	2286 FS	2086 BF	2086 F	2086 FS
LOA/Deck	23' 10" / 23' 5"	23' 10" / 22' 1"	23' 10" / 22' 1"	21' 10" / 21' 5"	21' 10" / 20' 1"	21' 10" / 20' 1"
Pontoon Length	22' 4"	22' 4"	22' 4"	20' 4"	20' 4"	20' 4"
Beam	8' 6"	8' 6"	8' 6"	8' 6"	8' 6"	8' 6"
Pontoon Diameter	25" 2 Tube	25" 2 Tube	25" 2 Tube	25" 2 Tube	25" 2 Tube	25" 2 Tube
Fuel Capacity (GAL)	30	30	30	30	30	30
Person Capacity	12	12	12	11	11	11

XPERIENCE

TIMELESS QUALITY & DESIGN

Built to last and engineered to stand the test of time, you'll savor every moment on our Godfrey Xperience series. No gimmicks, no compromises, just pure, enduring Godfrey quality on a pontoon that delivers everything you need and nothing you don't. Kick back, relax and take in your surroundings aboard one of our Fishing, Cruising, Split Bench or Lounge models. Lasting memories and smiles from ear to ear come standard.

Make it Last.

Standard Equipment

- 23" Outer Tubes on 8' wide models, & 25" Outer Tubes on 8' 6" models
- EZ Lift Manual Canopy
- Standard Analog Gauges
- Clarion® Basic Audio System with CMM-10 Head Unit, 4x20W RMS Output & Two 6.5" Speakers with Gray Grilles
- Click & Cruise Rail Technology
- Silver EZ Climb Ladder
- Four Stainless Steel Cleats & Silver Corner Castings
- Interior Courtesy Lights
- Two Movable Cupholders
- Cable Steering

Popular Options

- Performance, Sport Tube or Triple Tube Package
- EZ Lift Manual Double Canopy
- 5" Fishfinder / Chartplotter Display
- Wireless Gimbal Mount Phone Charger
- Reclining Captain's Chair
- Extreme Steering with Tilt Wheel
- Silver Rub Rail with Black Vinyl Insert
- Nightshade Towable Boat Cover
- Fire Extinguisher
- LED Docking Lights
- Ski Tow
- Windscreen
- SeaView™ Bow Gate

Pursue your passion.





EX 2286 SFLX with Navy Smooth Rail Skins, Black Rails & Autumn Tan Furniture

XPERIENCE LOUNGE



Standard Equipment for Xperience Lounge

- Single Flip Lounge Unit with Various Seating Configurations
- Clarion® Plus Audio System with CMM-10 Head Unit, 4x20W RMS Output & Four 6.5" Speakers with Gray Grilles
- Fastback Rails
- Stern Storage Box
- Standard Co-Captain's Chair
- Co-Captain's Cupholder Storage Unit

Popular Options for Xperience Lounge

- Changing Room Lounge Unit
- Upgraded Recliner
- Black Rails and Black Canopy

Additional key Xperience Standards & Popular Options shown on pg 66



XPERIENCE	2286 SFLX	2086 SFLX
LOA/Deck	23' 10" / 22' 1"	21' 10" / 20' 1"
Pontoon Length	22' 4"	20' 4"
Beam	8' 6"	8' 6"
Pontoon Diameter	25" 2 Tube	25" 2 Tube
Fuel Capacity (GAL)	30	19
Person Capacity	12	11



Expansive SFLX Layout with EZ Lift Manual Canopy for spacious comfort



Single Flip Lounge offers versatile configurations: face forward, recline backward, or lay flat for ultimate comfort



[Click Here to Learn
More About the
Xperience Lounge](#)

XPERIENCE LOUNGE

Kick up your feet and take in your surroundings aboard one of our Xperience Lounge models, allowing you to relish in the moment.

EX 2286 SFLX with Navy Smooth Rail Skins, Black Rails & Autumn Tan Furniture

XPERIENCE SPLIT BENCH



Standard Equipment for Xperience Split Bench

- Bow & Stern Quad Benches for Storage and Comfortable Seating
- Clarion® Plus Audio System with CMM-10 Head Unit, 4x20W RMS Output & Four 6.5" Speakers with Gray Grilles
- Co-Captain's Chair
- Round Table with Built-In Cupholders
- Four Movable Cup Holders

Popular Options for Xperience Split Bench

- Optional Upgraded Recliner
- Extended Deck

Additional key Xperience Standards & Popular Options shown on pg 66



Climb aboard with the EZ Climb Ladder for an afternoon of laid back fun



Optional Fishfinder/Chartplotter for precise navigation



XPERIENCE	2286 SBX	2086 SBX
LOA/Deck	23' 10" / 22' 1"	21' 10" / 20' 1"
Pontoon Length	22' 4"	20' 4"
Beam	8' 6"	8' 6"
Pontoon Diameter	25" 2 Tube	25" 2 Tube
Fuel Capacity (GAL)	30	19
Person Capacity	12	11

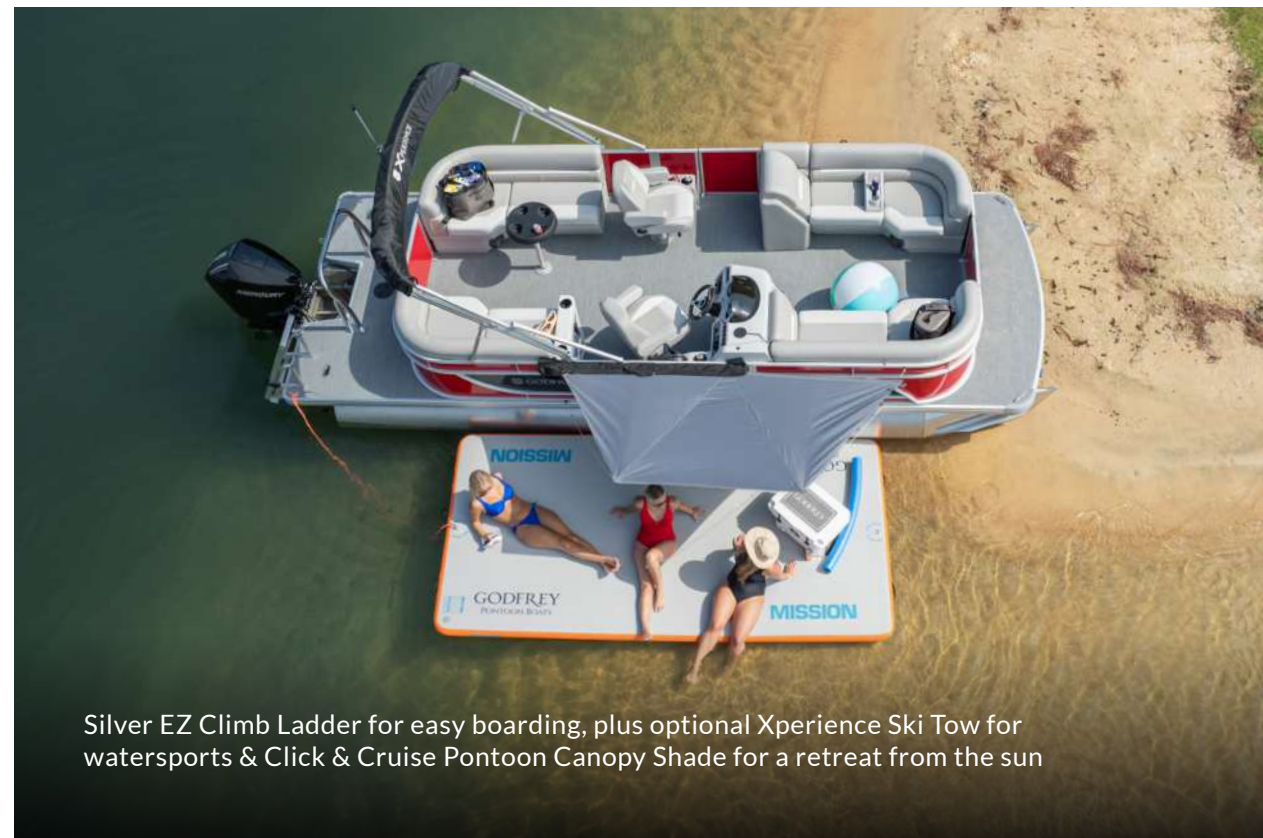

Silver EZ Climb Ladder for easy boarding, plus optional Xperience Ski Tow for watersports & Click & Cruise Pontoon Canopy Shade for a retreat from the sun



[Click Here to Learn More About the Xperience Split Bench](#)

XPERIENCE SPLIT BENCH

Enjoy every minute with your favorite people and make memories to last a lifetime for years to come with one of our Xperience Split Bench models.

EX 2286 SBX with Crimson Smooth Rail Skins, Black Mid-Body Graphics & Warm Gray Furniture

XPERIENCE CRUISE



Standard Equipment for Xperience Cruise

- Bow Benches for Storage & Comfortable Seating with Stern L-Bench Seating
- Round Table with Built-In Cupholders

Popular Options for Xperience Cruise

- Wireless Gimbal Mount Phone Charger
- Chaise Changing Room
- Extended Deck on 2086 & 1886 Models

Additional key Xperience Standards & Popular Options shown on pg 66



Comfortable L-Bench seating paired with a removable table for flexible lounging & easy entertaining

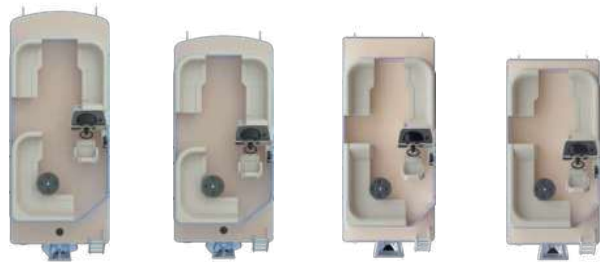

XPERIENCE

	2086 CXP	1886 CX	1880 CX	1680 CX
LOA/Deck	21' 10" / 20' 1"	19' 10" / 18' 1"	19' 11" / 18' 1"	17' 11" / 16' 1"
Pontoon Length	20' 4"	18' 4"	18' 4"	16' 4"
Beam	8' 6"	8' 6"	8'	8'
Pontoon Diameter	25" 2 Tube	25" 2 Tube	23" 2 Tube	23" 2 Tube
Fuel Capacity (GAL)	19	19	19	19
Person Capacity	11	10	9	8

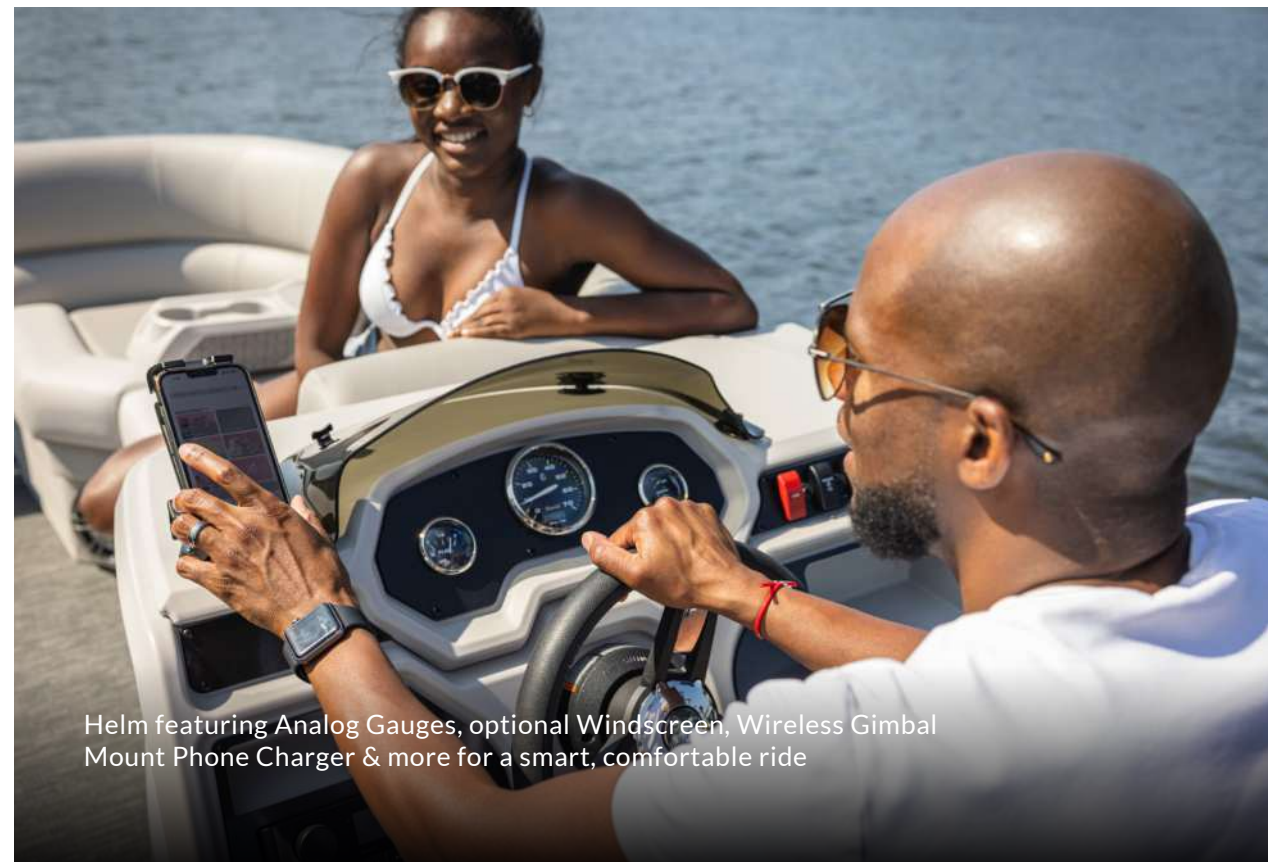

Helm featuring Analog Gauges, optional Windscreen, Wireless Gimbal Mount Phone Charger & more for a smart, comfortable ride



[Click Here to Learn
More About the
Xperience Cruise](#)

XPERIENCE CRUISE

Cruise into fun on the water on one of our Xperience Cruise models and create cherished memories with your favorite people on these versatile pontoons.

EX 2086 CXP with Black Smooth Rail Skins & Autumn Tan Furniture



[Click Here to Learn More About the Xperience Fishing](#)

Reel in the fun with one of our Xperience Fishing models. Endless laughs and smiles from ear to ear come standard.

EX 2086 BFX with Lagoon Smooth Rail Skins, Pearl White Mid Body Graphics & Warm Gray Furniture

XPERIENCE FISHING



Stern fish seats with integrated livewell for convenient, all-in-one fishing comfort & storage

XPERIENCE FISHING

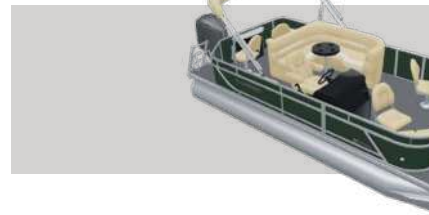

Standard Equipment for Xperience Fishing

- Bow or Stern Fish Seats
- Bow Cupholders on FX Models
- Trolling Motor Harness Kit with Plug & Half Gate on FX Models
- Round Table with Built-In Cupholders
- Livewell & Rod Holders (N/A BFX)
- Rear Fish Center (N/A BFX Model)

Popular Options for Xperience Fishing

- Chaise Changing Room
- Gimbal Mount Fishfinder / Chartplotter
- Vinyl Deck Gray Flooring

Additional key Xperience Standards & Popular Options shown on pg 66



Bow Fish seats with Click & Cruise Rod Holder Kit for easy access & hassle-free fishing

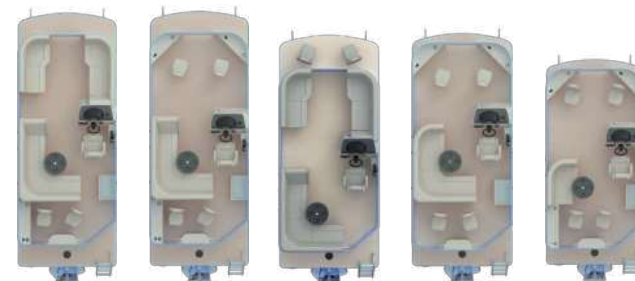

XPERIENCE

	2286 FSX	2286 FX	2086 BFX	2086 FX	1886 FX
LOA/Deck	23' 10" / 22' 1"	23' 10" / 22' 1"	21' 10" / 20' 1"	21' 10" / 20' 1"	19' 10" / 18' 1"
Pontoon Length	22' 4"	22' 4"	20' 4"	20' 4"	18' 4"
Beam	8' 6"	8' 6"	8' 6"	8' 6"	8' 6"
Pontoon Diameter	25" 2 Tube	25" 2 Tube	25" 2 Tube	25" 2 Tube	25" 2 Tube
Fuel Capacity (GAL)	30	30	19	19	19
Person Capacity	12	12	11	11	10

MIGHTY G

POWERFULLY COMPACT

The ultimate entry into boating, the Mighty G, is compact and highly maneuverable. The Mighty G is built on a true pontoon foundation ensuring a familiar and comfortable ride. Unlike other pontoons where power is an afterthought, the Mighty G was designed from the ground up to be powered by electric or gas propulsion. While it may be small, it truly is the Mighty G!

Make it last

Standard Equipment

- 23" Outer Tubes
- Standard Gauges
- Clarion® Audio System with GR10BT Head Unit & Two 6.5" Speakers with Matte Black Grilles
- Stainless Steel Telescoping EZ Climb Ladder
- Interior Courtesy Light
- USB Charging Port
- Nightshade Towable Boat Cover
- Four Fixed Cleats
- Cable Steering

Popular Options

- Torqeedo® Electric Motor Package
- Aluminum Trailer
- EZ Lift Manual Canopy
- Full Spectrum RGB Lighting
- Seat Base Closeouts
- Gray Vinyl Deck Flooring
- 3D Graphic Insert
- Interior Seat Frame Color Options
- Wireless Gimbal Mount Phone Charger





MG 1476 C with Metallic Pearl White Smooth Rail Skins, Blue 3D Graphic Insert & Platinum Gray Furniture

MIGHTY G CRUISE

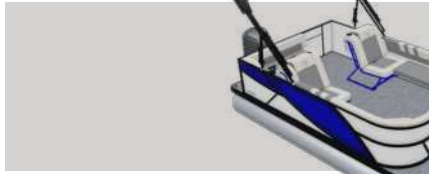

Standard Equipment for Mighty G Cruise

- Bow Filler Seat

Popular Options for Mighty G Cruise

- Gimballed Mounted Fishfinder / Chartplotter

Additional key Mighty G Standards & Popular Options shown on pg 76



Helm with Captain's bench seating for comfort & control at the wheel



Optional Torqeedo® 12.0 Package for quiet, electric propulsion



Optional Charcoal 3D Graphic Insert adds a sleek, modern accent to the Cruise Layout

MIGHTY G	1476 C
LOA/Deck	15' 8" / 14' 5"
Pontoon Length	14' 6"
Beam	7' 7"
Pontoon Diameter	23" 2 Tube
Fuel Capacity (GAL)	6
Person Capacity	6





[Click Here to Learn More About the Mighty G Cruise](#)

MIGHTY G CRUISE

Compact and highly maneuverable, the Mighty G Cruise is the ultimate entry into pontooning. Offering plenty of room for your favorite people, the Mighty G Cruise is compatible with either electric or gas propulsion.

MG 1476 C with Metallic Pearl White Smooth Rail Skins, Blue 3D Graphic Insert & Platinum Gray Furniture



[Click Here to Learn
More About the
Mighty G Fishing](#)

Compatible with either electric or gas propulsion, the Mighty G Fishing model is designed to be the perfect entry to electric angling, giving you all the room you need to cast in comfort.

MG 1476 F with Metallic Black Smooth Rail Skins, Charcoal 3D Graphic Insert & Platinum Gray Furniture

MIGHTY G FISHING



Aft Storage Module with integrated Rod Locker for organized gear & easy access while fishing

MIGHTY G FISHING



Standard Equipment for Mighty G Fishing

- Bow Fish Seats
- Aft Storage Module with Rod Locker

Popular Options for Mighty G Fishing

- 3D Graphic Insert

Additional key Mighty G Standards & Popular Options shown on pg 76



Optional Charcoal 3D Graphic Insert adds a bold, modern accent to the Fish Layout

MIGHTY G	1476 F
LOA/Deck	15' 8" / 14' 5"
Pontoon Length	14' 6"
Beam	7' 7"
Pontoon Diameter	23" 2 Tube
Fuel Capacity (GAL)	6
Person Capacity	6



CHOOSE YOUR EXTERIOR OPTIONS

XP Exterior



- Customization Options:
- (A) Smooth Rails Skins
 - (B) Fiberglass
 - (C) Furniture
 - (D) Fiberglass Seat Base
 - (E) Canvas

Sanpan Exterior

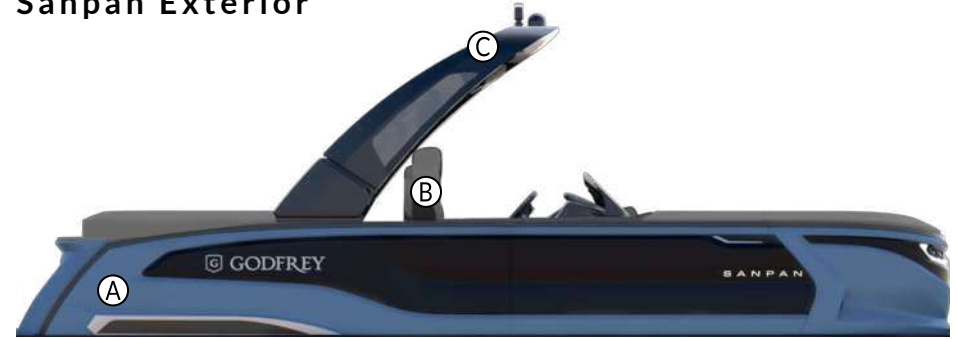

- Customization Options:
- (A) Fiberglass
 - (B) Furniture
 - (C) Canvas

AquaPatio Exterior

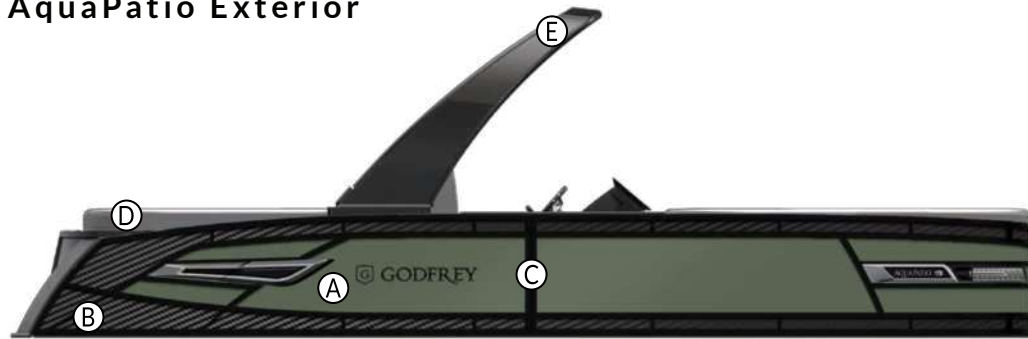

- Customization Options:
- (A) Smooth Rail Skins
 - (B) Graphics
 - (C) Rails
 - (D) Furniture
 - (E) Canvas

Monaco Exterior

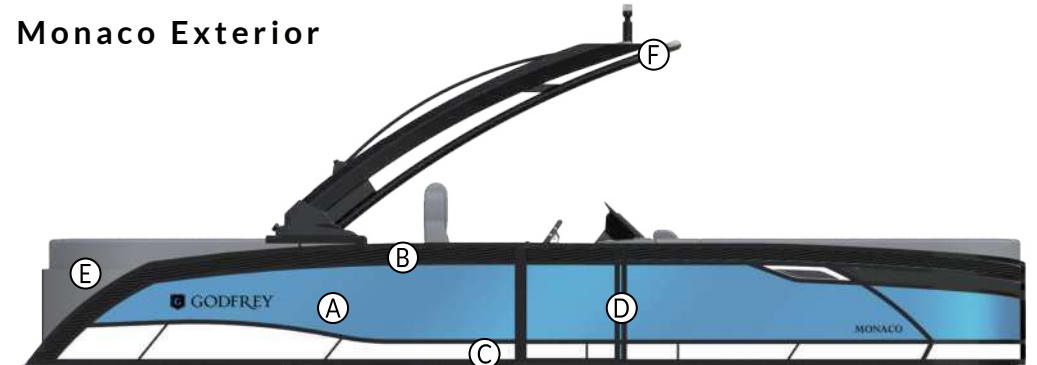

- Customization Options:
- (A) Smooth Rail Skins
 - (B) Top Graphic
 - (C) Bottom Graphic
 - (D) Rails
 - (E) Furniture
 - (F) Canvas

Sweetwater Exterior

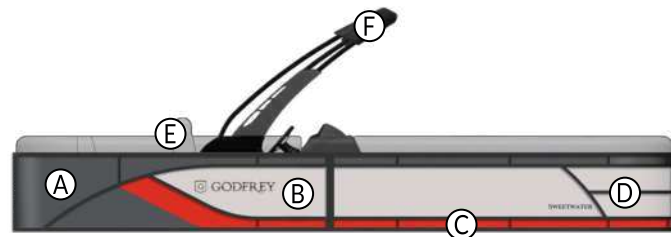

- Customization Options:
- (A) Smooth Rail Skins
 - (B) Mid-Body Graphic
 - (C) Low-Band Graphic
 - (D) Rails
 - (E) Furniture
 - (F) Canvas

Xperience Exterior

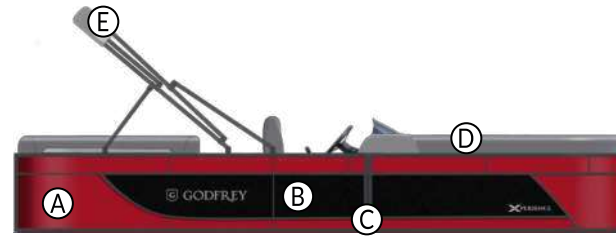

- Customization Options:
- (A) Smooth Rail Skins
 - (B) Mid-Body Graphic
 - (C) Rails
 - (D) Furniture
 - (E) Canvas

Mighty G Exterior

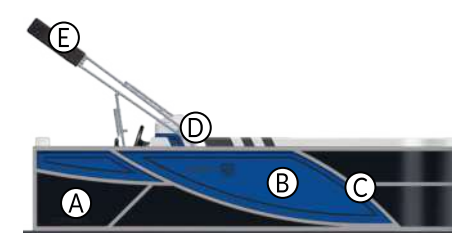

- Customization Options:
- (A) Smooth Rail Skins
 - (B) 3D Mat (2D Standard)
 - (C) Rails
 - (D) Furniture
 - (E) Canvas

CHOOSE YOUR EXTERIOR OPTIONS

XP Exterior (Smooth Rail Skins & Fiberglass)

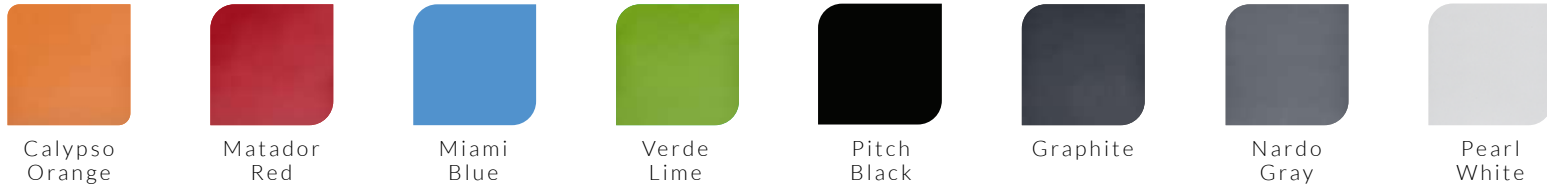

XP Fiberglass Seat Base

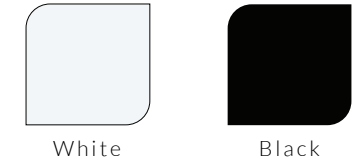

Sanpan Fiberglass



Sanpan Exterior Frame

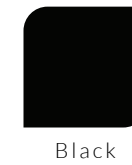

Smooth Rail Skins (AquaPatio, Monaco, Sweetwater, Xperience & Mighty G)



Graphics (AquaPatio, Monaco, Sweetwater & Xperience)



Rails (AP, MC, SW, EX & MG)



Mighty G Interior Frame Color



Mighty G 3D Marine Mat

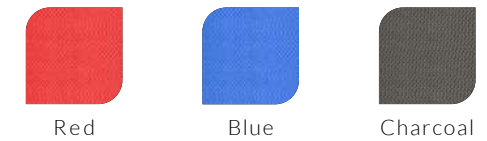

Canvas

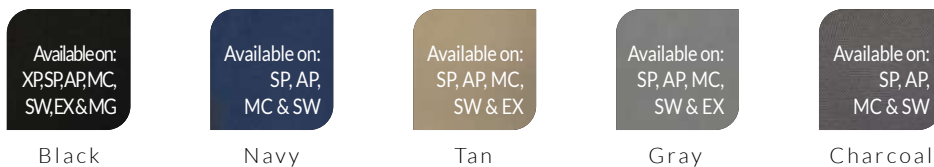

CHOOSE YOUR INTERIOR OPTIONS

XP Furniture

Standard Furniture



Slate Gray

Shown with Matador Red Accent Color



Standard Furniture



Pearl White

Shown with Matador Red Accent Color



Upgraded Furniture



Onyx Cool Touch

Shown with Nardo Gray Accent Color



Upgraded Furniture



Red Cool Touch

Shown with Nardo Gray Accent Color



Furniture Accents

			*Indicates Upgraded Accent Color. Accent Color not Required.		
			**Indicates Standard Accent Color		

Sanpan Furniture

Standard Furniture



Latte Ultra Soft

Shown with Upgraded Cavern Accent Color



Standard Furniture



Riverstone Ultra Soft

Shown with Upgraded Scarlet Accent Color



Upgraded Furniture



Saddle Cool Touch

Shown with Optional Navy Accent Color



Upgraded Furniture



Raven Cool Touch

Shown with Optional Bronze Accent Color



AquaPatio Furniture

Standard Furniture



Sahara Tan

Shown with Upgraded Quilting

Standard Furniture



Lunar Gray

Shown with Upgraded Quilting

Upgraded Furniture



Bayside Caramel

Shown with Upgraded Quilting

Upgraded Furniture



Protour Red

Shown with Standard Quilting

Upgraded Furniture



Cognac Cool Touch

Shown with Standard Quilting

Upgraded Furniture



Bayside Slate

Shown with Upgraded Quilting

Upgraded Furniture

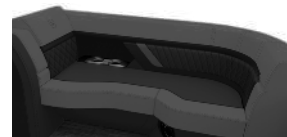

Eclipse Cool Touch

Shown with Standard Quilting



Monaco Furniture

Standard Furniture



Granite Soft Touch

Shown with Upgraded Quilting

Standard Furniture



Dune Soft Touch

Shown with Upgraded Quilting

Upgraded Furniture



Slate Ultra Soft Touch

Shown with Standard Quilting

Upgraded Furniture



Latte Ultra Soft Touch

Shown with Standard Quilting

Upgraded Furniture



Cognac Cool Touch

Shown with Standard Quilting

Upgraded Furniture



Eclipse Cool Touch

Shown with Standard Quilting

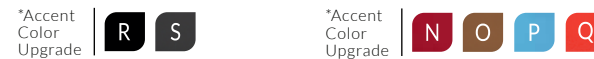

CHOOSE YOUR INTERIOR OPTIONS

Sweetwater Furniture

Standard Furniture



Select Gray

Shown with Anchor Gray Accent Color



Select Tan

Shown with Pacific Accent Color



Upgraded Furniture



Sienna Beige

Shown with Sage Accent Color & Optional Upgraded Wrapped Panels



Cognac Cool Touch

Shown with Pacific Accent Color & Optional Upgraded Wrapped Panels



Atlas Gray

Shown with Lagoon Accent Color & Optional Upgraded Wrapped Panels



Dune

Shown with Optional Upgraded Wrapped Panels



Granite

Shown with Optional Upgraded Wrapped Panels



Eclipse Cool Touch

Shown with Sunburst Accent Color & Optional Upgraded Wrapped Panels

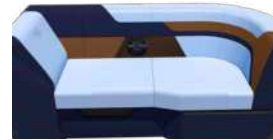

Riviera Blue Cool Touch

Shown with Sedona Tan Accent Color & Optional Upgraded Wrapped Panels



Xperience Furniture



Warm Gray



Autumn Tan

Mighty G Furniture



Platinum Gray

Quilting



XP Quilting



Sanpan Quilting

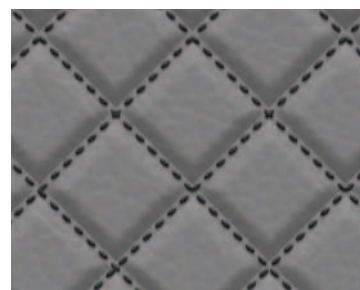

AquaPatio & Sweetwater Quilting

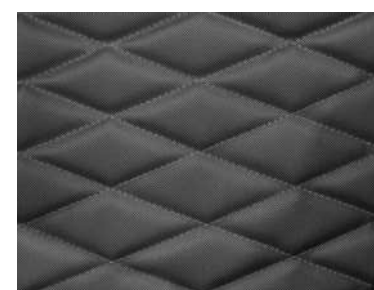

Monaco Quilting

[Click Here to Access All Interior & Exterior Options by Series](#)

Flooring (*Indicates Standard Flooring*)



Platinum Weave



Golden Weave

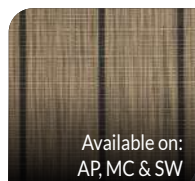

Harbor Beige

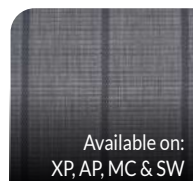

Harbor Gray



Vinyl Deck Gray
Fish Models Only



Lakeport Plank

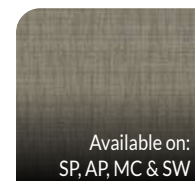

Mesa Beige

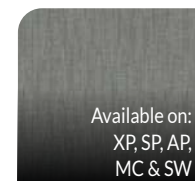

Voyager Gray



Onyx Weave
Cool Touch

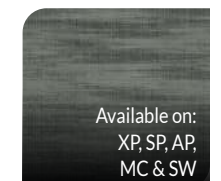

Driftwood
Cool Touch

PERFORMANCE PACKAGES



SP 2700 ULW Twin with Anthracite Fiberglass Exterior & Saddle Cool Touch Furniture

25" or 27" Two Tube



- 25" or 27" Tubes with Marine-Grade Decking & Exclusive Slipstream Motorpan
- Standard Slipstream Motorpan & 30-GAL Fuel Tank
- EX 19-GAL Remote Fill Fuel tank, or 30-GAL Direct Fill Option

27" Sport Tube



- 27" Sport Tube with Center Tube Lifting Strakes
- 27" Sport Tube has 25" Outer Tubes
- Standard Slipstream Motorpan & 30-GAL Fuel Tank
- GPS Speedometer

27" iMPACT Triple Tube



iMPACT

- 27" Center Tube with 25" Outer Tubes
- Oversized 6" Lifting Strakes
- Integrated Underdeck Skin & Inside Skirting
- GPS Speedometer
- For SW & EX 45-GAL Fuel Tank
- For XP, SP, AP & MC – new 2.0 Center Tube, updated to optimize people capacity and the ability to tilt engines out of the water. 48-GAL Fuel Tank

29" iMPACT+ Triple Tube



iMPACT+

- 29" Center Tube with 27" Outer Tubes
- Oversized 6" Lifting Strakes
- Integrated Underdeck Skin & Inside Skirting
- For SW & EX 61-GAL Fuel Tank
- For XP, SP, AP & MC – new 2.0 Center Tube, updated to optimize people capacity and the ability to tilt engines out of the water. 63-GAL Fuel Tank
- 121-GAL Fuel Tank for Twin Engines

PERFORMANCE PACKAGES

	23" 2 Tube 0.080" thick		25" 2 Tube 0.080" thick		27" 2 Tube 0.090" thick		27" Sport Tube 0.090" thick		27" iMPACT 0.090" thick		29" iMPACT+ 0.100" thick Single Engines 0.125" thick Twin Engines	
	PEOPLE	MAX HP	PEOPLE	MAX HP	PEOPLE	MAX HP	PEOPLE	MAX HP	PEOPLE	MAX HP	PEOPLE	MAX HP
XP 2700 TWIN	-	-	-	-	-	-	-	-	-	-	9 - 12	600 - 1000
XP 2700	-	-	-	-	-	-	-	-	-	-	15	450
XP 2500	-	-	-	-	-	-	-	-	-	-	14	450
SP 2700 TWIN	-	-	-	-	-	-	-	-	-	-	9 - 16	350 - 1000
SP 2700	-	-	-	-	-	-	-	-	14	450	17	450
SP 2500	-	-	-	-	-	-	-	-	16	300	18	400
SP 2300	-	-	-	-	-	-	-	-	13	300	16	300
AP 275	-	-	-	-	-	-	-	-	14	450	17	450
AP 256 TWIN	-	-	-	-	-	-	-	-	-	-	11 - 14	350 - 600
AP 255	-	-	-	-	-	-	-	-	16	300	15-17	400 - 450
AP 235	-	-	-	-	-	-	-	-	13	300	16	300
AP 215	-	-	-	-	-	-	-	-	13	200	15	250
MC 275	-	-	-	-	15	150	15	150	14	450	17	450
MC 255	-	-	14	150	16	150	15	150	16	300	18	400
MC 235	-	-	12	150	14	150	13	150	13	300	16	300
MC 215	-	-	11	150	12	150	11	150	12	200	15	250
SW 2486	-	-	14	150	15	150	15	150	15	300	17	400
SW 2286	-	-	12	150	14	150	13	150	13	300	16	300
SW 2086	-	-	11	150	12	150	11	150	12	200	14	250
EX 2286	-	-	12	150	14	150	13	150	13	300	16	300
EX 2086	-	-	11	90	11	150	11	150	12	200	14	250
EX 1886	-	-	10	75	-	-	-	-	-	-	-	-
EX 1880	9	75	11	75	-	-	-	-	-	-	-	-
EX 1680	8	60	9	70	-	-	-	-	-	-	-	-
MG 1476	6	50	-	-	-	-	-	-	-	-	-	-

*XP, Sanpan & AquaPatio Twin models receive Twin iMPACT+ Package

*Xperience 2086 Motor Pan upgrade available

WHY GODFREY PONTOON BOATS



Heritage & Future

We've been building pontoons since 1958; including one of the first aluminum pontoons & we look forward to another 60+ years!



Dealer Partners

Extensive network of experienced Dealer Partners; many have been with Godfrey for over 30 years!



Performance

From the Mighty G Series to the XP Series with up to 1000 HP, our boats are engineered to excite, thrill & spoil your families.



Choices

We provide numerous options on colors & content to get the boat of your dreams built with the features you want.



Construction

Overbuilt for a reason & we back it with our Lifetime Structural Warranty.



Value

More boat for your money, with higher resale value. Godfrey is a pontoon leader.



Quality

Our customers have spoken. Godfrey is built to last & we have the Industry awards to prove it.



Confidence

Certified to the highest Industry standards & we keep challenging ourselves daily to build the best product on the water.



Innovation

Pushing the boundaries, from our electric-powered Mighty G to the custom interactive screens on the XP.

Construction

As a recognized leader in quality, innovation and styling, Godfrey Pontoon Boats continues to set the standard for design, construction and innovation. In fact, Godfrey pioneered many of the systems that have become industry standards. With over 60 years of experience, we work hard to build boats that will be part of your family for years to come.



Built to Last

There are plenty of pontoon manufacturers out there today, but how many can say they've been building boats for over half a century?

Godfrey Pontoon Boats introduced one of the first all-aluminum pontoon boats, Sanpan, in 1958.



Robotic Welding

State-of-the-art, robotic welding provides the highest quality welds in every boat we build. Godfrey Pontoon Boats is one of the first manufacturers in the industry to use robotic welding.



Heavy-Duty Nose Cones

Our heavy-duty nose cones not only provide added strength, but are part of what creates the lift, speed, and smooth ride that Godfrey is known for.



6" Lifting Strakes

Our 6" strakes provide up to 50% more lift than competitors that use smaller strakes. This lift results in higher speeds, improved handling, quicker planing & better fuel economy.



Chambered Tubes

Our tubes are engineered for strength by using a beaded baffle between every chamber. These are welded in place & the chambers are seam welded together to produce a robust tube with strength needed for our lifetime structural warranty.



Spray Fins

We use 24" long beveled, heavy duty extruded spray fins. We then weld them on tubes at specific locations to control water management at all speeds, keeping you and your crew high and dry.

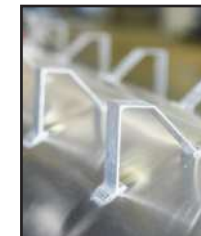

Saddle Brackets

At 5", our extruded saddle brackets are wider & taller than competitors. We also use thicker material for the feet where they are welded to the tubes. This bracket is the foundation for the entire boat & part of the reason for our higher, smoother ride.



F-Channel Rubrail

The thickness & shape of the extruded F-Channel rubrail creates a durable deck-edge finish to protect your boat from dock rash & dings. It adds to our structural integrity & is not just for looks.

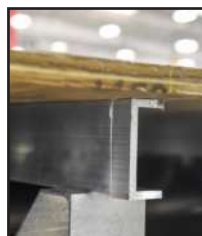

3" C-Channel

We use taller, thicker and more closely spaced C-Channels to connect the deck to the pontoons. When combined with our extruded saddle brackets, you get not only a sturdier-built boat, but also a higher, more comfortable ride.



Elevator Bolts

We use Stainless Steel Elevator Thru Bolts & Nylock nuts vs sheet metal screws used by competitors. We secure our decks with precision, allowing bolts to stay intact and anchored to the foundation.

GODFREY APPAREL & ACCESSORIES



Customize Your Ride—Your Way

Godfrey's Click & Cruise system turns your pontoon into a customizable space that adapts to your crew, your style, and your day. Available on all 2026 Sanpan, Monaco, Sweetwater, and Xperience models, this modular rail system lets you easily attach, move, or remove accessories—no tools needed. Its all about convenience, versatility, and style.

Click Here to Learn more about **Click & Cruise**



Flagpole Kit



Rod Holder Kit



Sports Rack



Pontoon Sandbar Shade

Experience the Godfrey Lifestyle

For over 60 years, Godfrey Pontoon Boats have been synonymous with world-class craftsmanship and, more importantly, the quality of time spent with loved ones. We've incorporated that same commitment to bring you a wide range of apparel and accessories that redefines the boating experience. Our thoughtfully designed gear enhances your Godfrey lifestyle on and off the water, empowering you to create unforgettable moments with the ones closest to you.

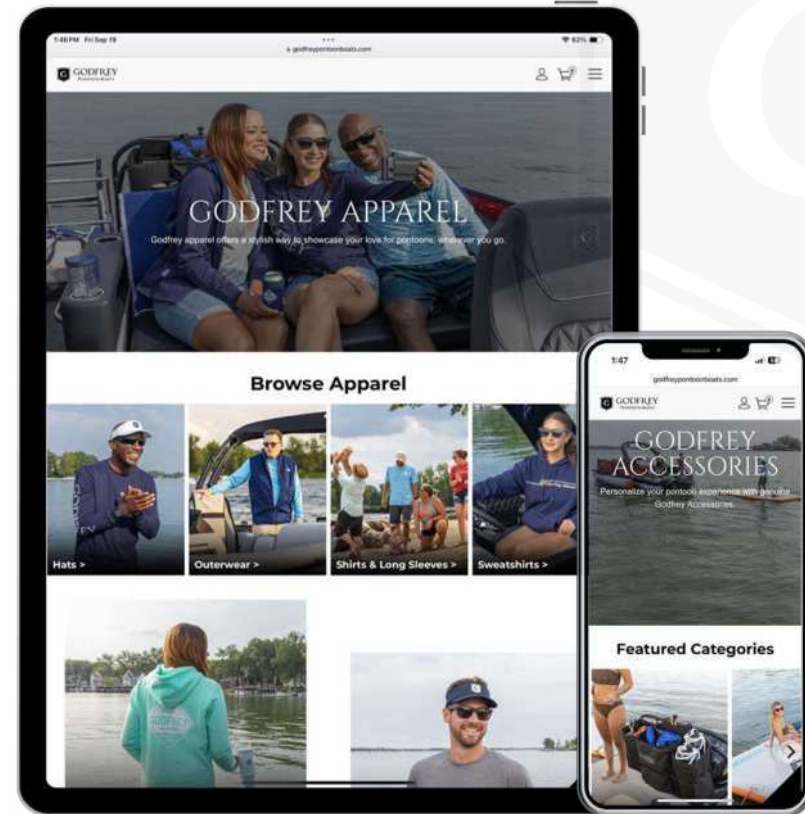

Click here to **To Access Apparel**

Click here to **To Access Accessories**





Lifetime Structural Warranty

Limited Lifetime coverage against structural failure of all pontoon tubes, StrataTech Chassis (under-deck structure), rails and gates so long as the original owner owns the product. Free of charge for materials and labor.

Lifetime Marine Deck PTP Deck Panels

Limited Lifetime coverage to repair or replace any Marine Deck PTP deck panels and related PTP products free of charge for materials and labor. Lifetime warranty is exclusive to the original retail product owner and the balance of 10 years from original purchase date can be transferred to a second owner. Please visit your local dealer for specifics regarding transfer of warranty coverage.

***10 Year Flooring & Canopy Fabrics**

Carpet, canopy fabric and canopy frames warranted free of charge for materials and labor. Warranty extends to the first retail purchaser only and begins on date of delivery to first retail purchaser.

***10 Year Furniture & Upholstery**

Foam seats and furniture upholstery warranted free of charge for materials and labor. Warranty extends to the first retail purchaser only and begins on date of delivery to first retail purchaser.

***5 Year Electrical & 10 Year Components**

5 year coverage of electrical, electronics, and hydraulics. 10 year coverage of all other factory installed components. Warranty extends to the first retail purchaser only and begins on date of delivery to first retail purchaser.

* For Mighty G models, a Limited 3-Year warranty applies.

Boats depicted in this brochure may feature parts and accessories that are not standard features of the base model of the boat they accompany and may depict colors, parts and accessories that are subject to availability and subject to change without notice. All performance and/or feature and benefit claims are based upon data available at time of printing. All specifications, claims and information contained in this brochure are based upon current knowledge and printed material available at time of publication. Specifications and descriptions are subject to change without notice. Godfrey assumes no responsibility for availability of or changes to colors, parts and accessories depicted, changes in pricing or specifications, or for any inaccuracies or omissions in this brochure.

[Click Here to Access
Interactive Extended
Digital Brochure](#)

[Click Here to Access
Interactive Digital
Product Guide](#)

[Click Here to Access
3D Build-A-Boat](#)



GODFREY
PONTON BOATS

4500 Middlebury St, Elkhart, IN 46516
United States of America

Visit Godfrey Pontoon Boats
godfreypontoonboats.com

@GodfreyPontoonBoats



Make it last.

Model Year 2026

Godfrey is a registered trademark of Highwater Marine LLC, a wholly-owned subsidiary of Polaris Industries Inc. When you're enjoying your new Godfrey Pontoon Boat, make sure you and all passengers aboard obey all applicable laws and follow all warnings and instructions in the owner's manual. Never boat under the influence of drugs or alcohol. Boats depicted may depict parts that are subject to availability and subject to change without notice.; Mercury® is a registered trademark of Brunswick Corporation; JL® is a registered trademark of JL Audio, Inc.; Simrad® is a registered trademark of Kongsberg Discovery AS; Suzuki® is a registered trademark of Suzuki Motor Corporation; Yamaha® is a registered trademark of Yamaha Hatsudoki Kabushiki Kaisha Corporation; Lillipad® is a registered trademark of BM&S Consulting LLC (LIMITED LIABILITY COMPANY; ILLINOIS, USA); Clarion® is a registered trademark of Clarion Co., Ltd.; La Croix® is a registered trademark of Everfresh Beverages, Inc.; Lowrance® is a registered trademark of Navico Group Americas LLC; Mission® is a registered trademark of MISSION CORP.; Seastar® Solutions is a registered trademark of Marine Acquisition Corp.; Torqeedo® is a registered trademark of Torqeedo GmbH; Unless noted, all trademarks are the property of Highwater Marine, LLC, wholly-owned subsidiaries of Polaris Industries Inc. © 2025 Highwater Marine LLC.

www.godfreypontoonboats.com